

# Hemodynamics

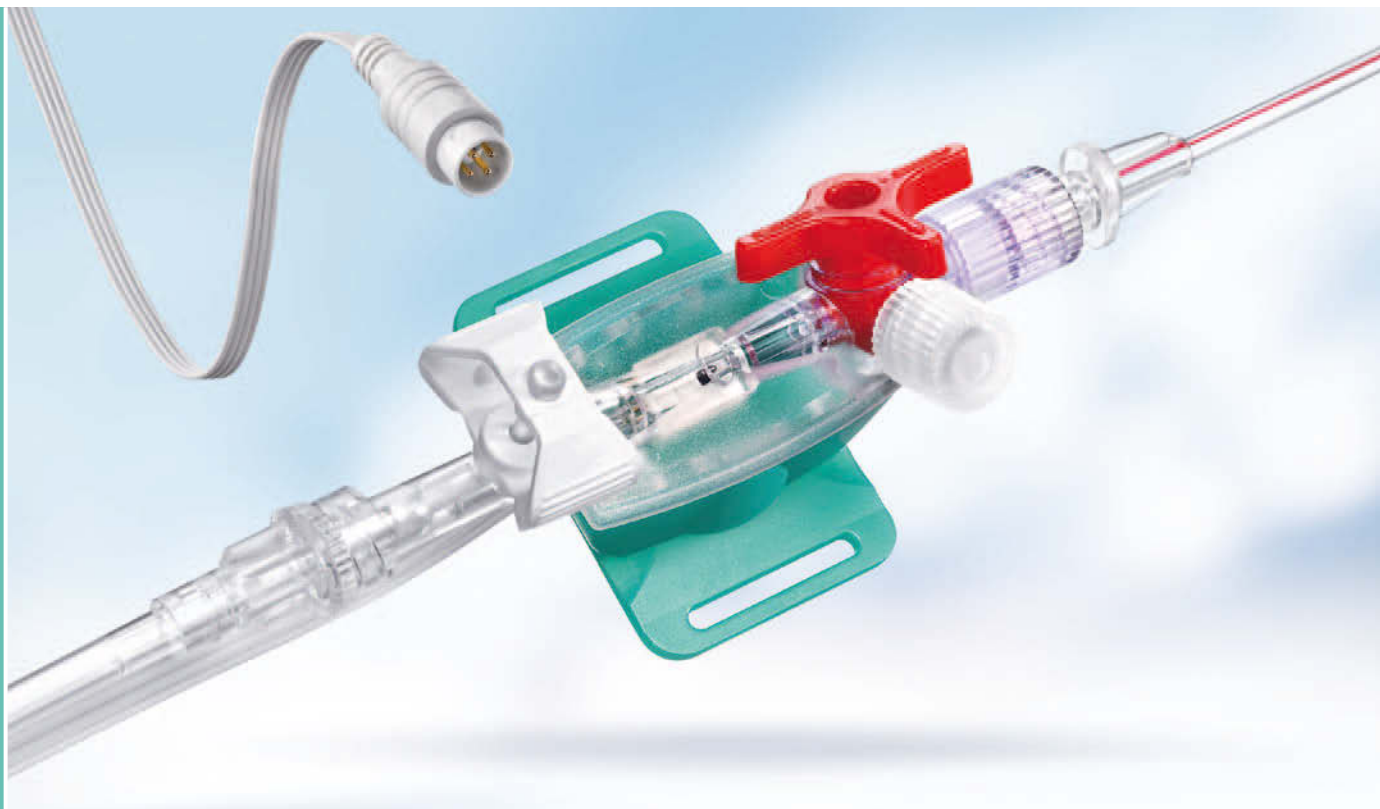

Vascular Systems



# Vascular Systems

Products for minimal-invasive diagnostics and therapy

Product field	Product group	Product	Page
Balloon floatation catheters for measurement of haemodynamic pressure and cardiac output	<b>Corodyn</b>	Corodyn P1 Corodyn P2 Corodyn TD Corodyn TD-I Corodyn TD touch-free Corodyn TD-I touch-free Corodyn accessories Corodyn technical data	4 4 5 5 6 6 7 8
	<b>Eledyn</b>	Eledyn stimulation probe Add-ON set for Eledyn	9 9
	<b>Eledyn 2/FX</b>	Eledyn 2	10
Monitoring kits with disposable transducer for physiological pressure measurement	<b>Combitrans®</b>	Combitrans® Monitoring kits Combidyn® pressure tubing with three-way stopcock Exadyn-Combitrans® Monitoring kits Exadyn-Combitrans® PVC-free Combitrans® Monitoring kit "Fixation tape" Combitrans® Monitoring double kit Combitrans® Monitoring triple kit Combitrans® disposable transducer Combitrans® / Intrafix M Haemofix®-Combitrans® Monitoring kit Haemofix®-Exadyn Monitoring kit Haemofix®-Combitrans® Monitoring kit double Haemofix® accessories Combitrans® attachment plates Combitrans® Easy Click Exadyn-Combitrans® Easy Click Combitrans® EC Special Combitrans® EC	11 11 12 12 13 14 14 15 15 16 16 16 16 17 18 19 20 21
Monitoring kits with reusable transducer for physiological pressure measurement	<b>Combidyn®</b>	Combidyn® Monitoring kits SensoNor 844 reusable pressure transducer Combidyn® disposable domes Combidyn® flush device	22 23 23 23
Pressure tubing for physiological pressure measurement	<b>Combidyn®</b>	Combidyn® PVC Tubings Combidyn® Polyethylene Tubings	24 25
Catheter introducer sheaths for Seldinger technique	<b>Intradyn®</b>	Intradyn® venous Intradyn® Special Basic Intensive Care Kit Intradyn® Special Complete Intensive Care Kit Intradyn® accessories Intradyn® Tear-Away	26 27 28 29 30
Arterial puncture acc. to Seldinger technique	<b>Arteriofix</b> <b>Arteriofix V</b>	Arteriofix Arteriofix V	31 32
APPENDIX	<b>Combitrans®</b>	Combitrans®-Monitoring-Cables Conversion tables	29 - 37 38

# Corodyn P1/P2

Balloon floatation catheters made of Polyurethane (PUR)

Corodyn P1/P2	Code-Number	Sales unit-pcs.
---------------	-------------	-----------------

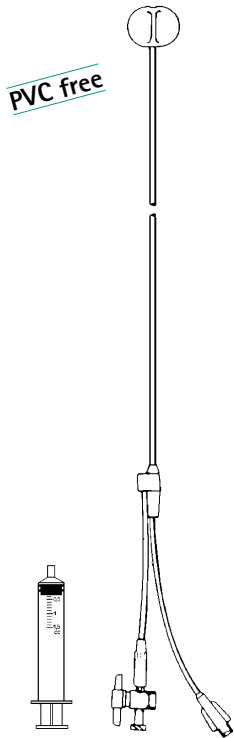

Balloon floatation catheters for hemodynamic pressure measurement

- catheter length 110 cm
- catheter marking every 100 mm from the catheter tip as an indicator of depth of introduction and position of catheter
- easy handling
- safe insertion
- radio-opaque
- excellent pressure transmission

### Corodyn P1

Balloon floatation catheter with distal lumen

- made of PUR
- antithrombogenic material
- free of toxic plasticizers

F5	<b>5011590</b>	5
F6	<b>5011698</b>	5
F7	<b>5011795</b>	5

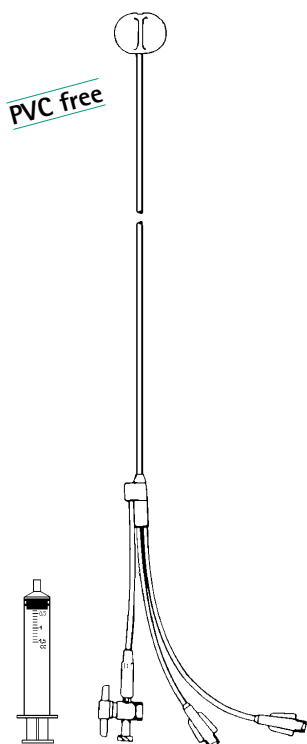

### Corodyn P2

Balloon floatation catheter with two lumina for simultaneous pressure measurement and application of infusions or medications

- made of PUR
- antithrombogenic material
- free of toxic plasticizers
- distance between exit port and catheter tip 20 cm

F7	<b>5021740</b>	5
----	----------------	---

# Corodyn TD / TD-I

Thermodilution catheters with balloon made of Polyurethane (PUR)

	Corodyn TD	Code-Number	Sales unit-pcs.
--	------------	-------------	-----------------

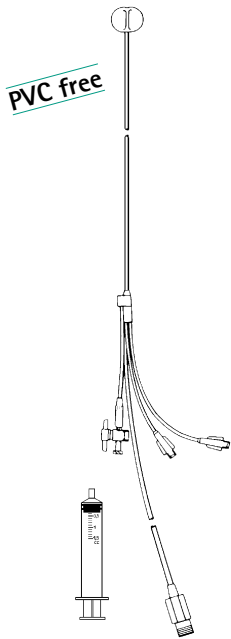

Thermodilution catheter with balloon for measurement of haemodynamic pressure and cardiac output

- catheter (4 lumina) with lumen for injection of a cold bolus and distal lumen for pressure measurement
- catheter length 110 cm
- thermistor, 35 mm from catheter tip
- catheter marking every 100 mm from the catheter tip as an indicator of depth of introduction and position of catheter
- easy handling
- safe introduction
- radio-opaque
- excellent pressure transmission
- thermistor resistance at 37°C  $14,000 \Omega \pm 15 \%$ , sensitivity  $520 \Omega/^\circ\text{C}$
- special three-pin plug connector for all standard computers and patient monitors
- made of PUR
- antithrombogenic material
- free of toxic plasticizers

## Corodyn TD

F5	<b>5041406</b>	5
F6	<b>5041414</b>	5
F7	<b>5041422</b>	5
F7, S-Tip	<b>5041945</b>	5

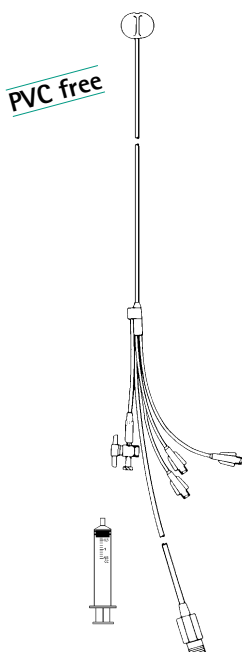

## Corodyn TD-I

Thermodilution catheter with 5 lumina  
 - same catheters as Corodyn TD but with additional lumen for simultaneous pressure measurement resp. for the application of infusions or medications

## Corodyn TD-I

PUR, F 7,5	<b>5041856</b>	5
------------	----------------	---

# Corodyn touch-free

Thermodilution catheters with balloon made of Polyurethane (PUR)

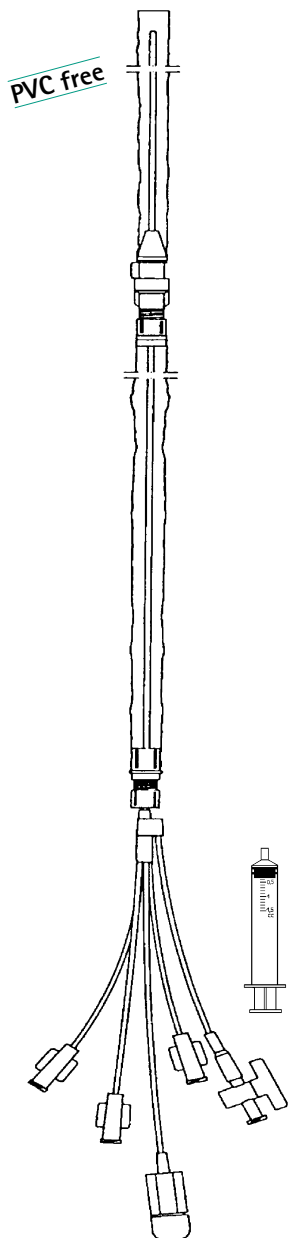

## Corodyn TD touch-free

Code-  
Number

Sales  
unit-pcs.

Thermodilution catheter with balloon for measurement of haemodynamic pressure and cardiac output

### Catheter with touch-free contamination guard

- catheter contamination guard (110 cm)
- test chamber
- special connection of the contamination guard to the sheath

### Corodyn TD catheter

- catheter (4 lumina) with lumen for injection of a cold bolus and distal lumen for pressure measurement
- catheter length 110 cm
- thermistor, 35 mm from catheter tip
- catheter marking every 100 mm from the catheter tip as an indicator of depth of introduction and position of catheter
- easy handling
- insertion
- radio-opaque
- excellent pressure transmission
- thermistor resistance at 37 °C  $14,000 \Omega \pm 15 \%$ , sensitivity  $520 \Omega/^\circ\text{C}$
- special three-pin plug connector for all standard computers and patient monitors
- made of PUR
- antithrombogenic material
- free of toxic plasticizers

### Corodyn TD touch-free

F7

5040035

5

### Corodyn TD-I touch-free

Thermodilution catheter with 5 lumina

- same catheter as Corodyn TD but with additional lumen for simultaneous pressure measurement resp. for the application of infusions and medications

### Corodyn TD-I touch-free

F7.5

5040043

5

# Corodyn

## Accessories

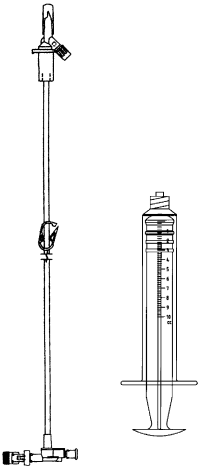
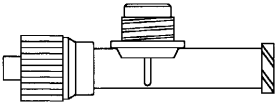
		Code- Number	Sales unit-pcs.
	<p><b>Closed Injectate Delivery System for measurement of cardiac output by thermodilution</b></p> <ul style="list-style-type: none"> <li>- simplification of the cardiac output measurement</li> <li>- contamination guard provides a closed system</li> </ul>		
	<p><b>CO-Kit</b></p> <p>Closed Injectate Delivery System to measure the cardiac output with room temperature injectate</p> <ul style="list-style-type: none"> <li>- Multi Add tubing system</li> <li>- dual-check-valve</li> <li>- syringe, 10 ml</li> <li>- three-way-stopcock</li> </ul>		
	<p>CO-Kit</p>	<b>5040011</b>	25
	<p><b>In-line temperature probe</b></p> <p>For in-line injectate temperature sensing at catheter injection site, sterile</p> <ul style="list-style-type: none"> <li>- with screw connection</li> <li>- with snap lock</li> </ul>		
	<p>with screw connection</p>	<b>5040086</b>	25
	<p>with snap lock</p>	<b>5040088</b>	25

# Corodyn

## Balloon floatation catheters Technical data

Catheter	French size	B. Braun Introducer	Length	Maximum Balloon Capacity	Inflated Balloon Diameter	Recommended Guide wire	Distance between Exit Port and Tip	Inner Diameter of Distal Opening
Corodyn P1	F5	F5	110 cm	0.75 cm <sup>3</sup>	8 mm	0.025"		0.025"
	F6	F6	110 cm	1.25 cm <sup>3</sup>	10 mm	0.025"		0.030"
	F7	F7	110 cm	1.50 cm <sup>3</sup>	12 mm	0.038"		0.039"
Corodyn P2	F7	F7	110 cm	1.50 cm <sup>3</sup>	12 mm	0.018"	20 cm	0.019"

Catheter	French size	B. Braun Introducer	Length	Maximum Balloon Capacity	Inflated Balloon Diameter	Recommended Guide wire	Distance betw. Injection Lumen and Tip	Distance betw. Infusion Lumen and Tip	Distance Thermistor cm	Inner Diameter of Distal Opening
Corodyn TD	F5	F5	110 cm	0.75 cm <sup>3</sup>	8 mm	0.018"	29 cm		3.5	0.019"
	F6	F6	110 cm	1.25 cm <sup>3</sup>	10 mm	0.025"	29 cm		3.5	0.025"
	F7	F7	110 cm	1.50 cm <sup>3</sup>	12 mm	0.025"	29 cm		3.5	0.030"
Corodyn TD-I	F7,5	F8	110 cm	1.50 cm <sup>3</sup>	12 mm	0.025"	29 cm	31 cm	3.5	0.030"

Length marking every 100 mm from the catheter tip.

### Catheter computation constants

Injectate Temperature (°C)		0 °C - 5 °C			23 °C - 25 °C		
Injectate Volume (cm <sup>3</sup> ) (V <sub>i</sub> )		3	5	10	3	5	10
Computation constants (k)	5 FR., 100 cm	0.144	0.239	0.481	0.146	0.246	0.489
	6 FR, 100 cm	0.158	0.268	0.547	0.163	0.277	0.558
	7 FR, 110 cm	0.160	0.274	0.561	0.162	0.278	0.558
	7.5 F, 110 cm	0.160	0.274	0.561	0.162	0.278	0.558
	8 F, 110 cm	0.160	0.274	0.561	0.162	0.278	0.558

$$k = \frac{(1.08)(C_p)60(V_i)}{1000}$$



# Eledyn

Bipolar temporary balloon probe for anaesthesia and intensive care

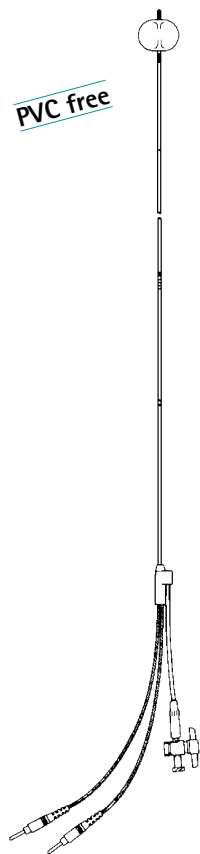

## Eledyn

Code-  
Number

Sales  
unit-pcs.

Bipolar temporary balloon probe for transvenous heart stimulation

- excellent push and flexibility
- catheter material: antithrombogenic Polyurethane (PUR), free of toxic plasticizers
- the use of stainless steel for electrode rings and wires avoids formation of galvanic elements
- stainless steel, gold-plated 2 mm pins

▪ **stimulation probe** 110 cm

- catheter marking every 100 mm from tip of the probe as an indicator of depth of introduction and position of the probe
- bipolar

▪ **electrodes**

- electrode length 3 mm
- electrode distance 10 mm
- torque stability due to material and design
- radio-opaque

▪ **with floatation balloon**

▪ **Omnifix® Lock**

- disposable syringe
- with plunger stop for exact volume of air / CO2 for balloon inflation
- for connection to balloon lumen with stopcock

Eledyn stimulation probe with balloon F5

**5101506**

5

**Add-ON kit for Eledyn 2/F6 and Eledyn F5 EB10**

- 1 Contamination guard
- 4 Gauze pads 10 x 10cm, 8 plies
- 1 Cutfix scalpel Fig. E11
- 1 Seldinger puncture needle 1.3 x 70 mm, light pink
- 1 Guide wire J3 SFU70-035 in dispenser and with a straightener
- 1 Intradyn® venous hemostasis introducer F6 with a blue stop cock, two closing cones and one protection cover.

Add-ON set for Eledyn 2/F6 and Eledyn F5 EB10

**5150020**

10

# Eledyn 2/FX

Bipolar temporary stimulation probe for anaesthesia, intensive care and electrophysiology

	Eledyn 2/FX	Code-Number	Sales unit-pcs.
--	-------------	-------------	-----------------

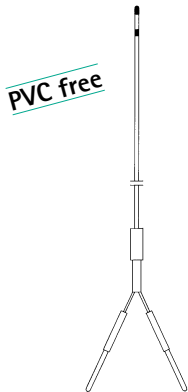

Bipolar temporary stimulation probes for transvenous heart stimulation and electrophysiology

- radiopaque catheter body
  - made of antithrombogenic Polyurethane
  - free of toxic plasticizers
  - length markings in step of 10 cm
  - touch protected connectors
- color coded hub for easy identification of catheter sizes

**Technical data**

- electrode distance: 10 mm
- material: stainless steel
- effective length: 112 cm
- catheter material: Polyurethane, radio-opaque
- resistance: < 60 Ω
- plug: 2 mm stainless steel

**Eledyn 2/F4**

Eledyn 2/F4 - straight	<b>5151503</b>	5
Eledyn 2/F4 - C	<b>5151520</b>	5

Eletrode surface: ring 12 mm<sup>2</sup>

**Eledyn 2/F5**

Eledyn 2/F5 - straight	<b>5151538</b>	5
Eledyn 2/F5 - C	<b>5151554</b>	5

Eletrode surface: ring 15 mm<sup>2</sup>

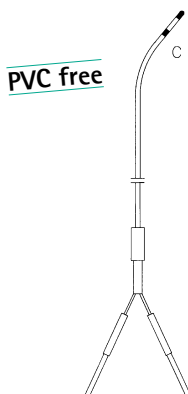

**Eledyn 2/F6**

Eledyn 2/F6 - straight	<b>5151562</b>	5
Eledyn 2/F6 - C	<b>5151589</b>	5

Eletrode surface: ring 19 mm<sup>2</sup>

All Eledyn F4 an F5 probes include a peel-away cannula and a connectable Hemostop venous.

**Recommended introducer for F6 probes:**

Tear-Away introducer sheath F6

# Combitrans®

## Monitoring kits with disposable transducer Basic kits

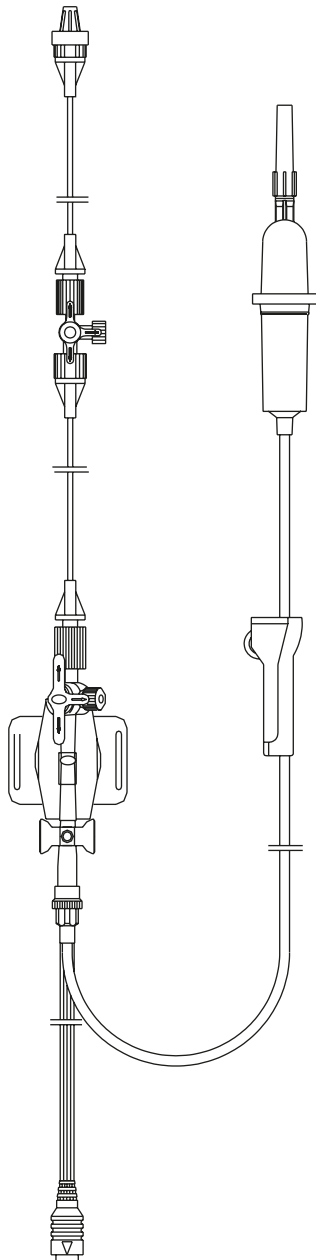

### Combitrans®

Code-  
Number

Sales  
unit-pcs.

Monitoring kit with disposable transducer for physiological pressure measurement

#### Complete system

- for high transmission of pressure signal
- time reducing
- avoids contamination at connections and during blood sampling

#### Combitrans® Monitoring kit

- **Intrafix M**
  - special administration kit for pressure measurement
- **Combitrans® flush device**
  - quick flush rate  $\geq 1$  ml/s
  - continuous flush rate 3 ml/h at 300 mmHg
- **Combitrans® disposable transducer**
  - compact and 100 % tested unit with excellent pressure transmission
  - can be used in combination with all CF-class monitors
  - adapts to interface cable with plug connection
  - modern chip technology for an accurate registration of values
  - precalibrated sensor with constant electrical parameters (sensitivity, linearity, zero stability)
  - straight fluid channel for an easy air-bubble free filling
- **Discofix-3**
  - 2 three-way stopcocks red (arterial), blue (venous) or yellow (pulmonal arterial)
- **Combidyn® pressure tubing 125 cm**
  - $\varnothing 1.5 \times \varnothing 2.7$  mm
  - with red (arterial), blue (venous) or yellow (pulmonal arterial) stripe
- **Combidyn® pressure tubing 20 cm**
  - $\varnothing 1.5 \times \varnothing 2.7$  mm
  - with red (arterial) stripe, blue (venous) or yellow (pulmonal arterial) stripe

#### Combitrans® Monitoring kit

red (arterial)	<b>5202620</b>	20
blue (venous)	<b>5202604</b>	20
yellow (pulmonal arterial)	<b>5202617</b>	20

#### Combidyn® pressure tubing with three-way stopcock

- pressure tubing, red,  $\varnothing 1.5$  mm x  $\varnothing 2.7$  mm, 20 cm
- connected three-way stopcock, red

Combidyn® pressure tubing with three-way stopcock	<b>5208599</b>	50
---	----------------	----

# Exadyn-Combitrans®

Monitoring kits with disposable transducer

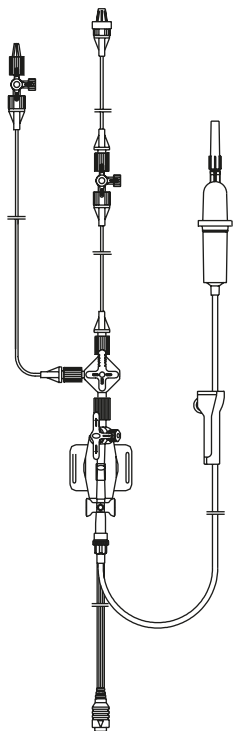

## Exadyn-Combitrans®

Code-  
Number

Sales  
unit-pcs.

Monitoring kit with disposable transducer for measurement of arterial pressure and CVP (central venous pressure)

### Complete system

- for optimal transmission of pressure signal
- time reducing

### Exadyn-Combitrans® Monitoring kit

- **Intrafix M**
  - special administration kit for pressure measurement
- **Combitrans® flush device**
  - quick flush rate  $\geq 1$  ml/s
  - continuous flush rate 3 ml/h at 300 mmHg
- **Combitrans® disposable transducer**
  - compact and 100 % tested unit with excellent pressure transmission
  - can be used in combination with all CF-class monitors
  - adapts to interface cable with plug connection
  - modern chip technology for an accurate registration of values
  - precalibrated sensor with constant electrical parameters (sensitivity, linearity, zero stability)
  - straight fluid channel for an easy air-bubble free filling
- **Discofix-3**
  - 2 three-way stopcocks red handle (arterial)
  - 1 three-way stopcock blue handle (venous)
- **Combidyn® pressure tubing 125 cm**
  - $\varnothing 1.5 \times \varnothing 2.7$  mm
  - with red (arterial) or blue (venous) stripe
- **Combidyn® pressure tubing 20 cm**
  - $\varnothing 1.5 \times \varnothing 2.7$  mm
  - with red (arterial) stripe
- **Exadyn special 90° stopcock**
  - 90° two-way safety stopcock for switch between arterial and venous measurement
  - no shunts possible

Exadyn-Combitrans® Monitoring kit

5202507

20

PVC free

### Exadyn-Combitrans® Monitoring kit PVC-free

Monitoring kit with disposable transducer for measurement of arterial pressure and CVP  
- same configuration as above, however, **all components PVC-free** for active environmental protection

Exadyn-Combitrans® Monitoring kit PVC-free

5212391

20

### Exadyn-Combitrans® Monitoring kit long tubings

Monitoring kit with disposable transducer and long tubings for measurement of arterial pressure and CVP

- same configuration as above, but with 200 cm long tubings instead of 125 cm

Exadyn-Combitrans® Monitoring kit long tubings

5206994

20

# Combitrans® Special

Monitoring kits with disposable transducer Customized kit solutions

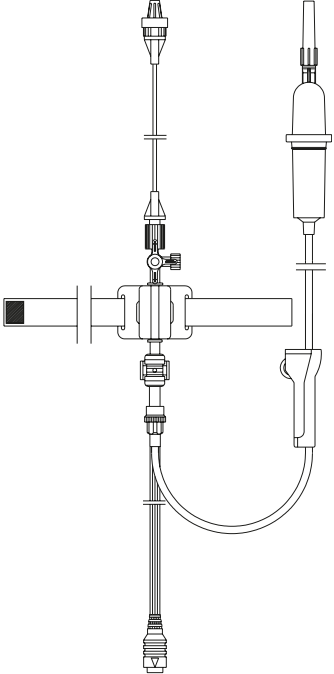
		Code- Number	Sales unit-pcs.
	<p><b>Create your individual Combitrans® monitoring kit for invasive pressure measurement</b></p> <p>Individual and user-friendly solutions are combined with economical and ecological advantages:</p> <ol style="list-style-type: none"> <li><b>1. Service through sales representative:</b> Demand analysis - kit proposal - sample and individual kit configuration according to your requirements - offer</li> <li><b>2. Customized and user-friendly:</b> Your made-to-order solution out of our large B. Braun range - reduction of preparation time - designed and packaged due to customer specification - one order number</li> <li><b>3. Economical:</b> Standardization of work practices - relief of clinic personnel - easy material management - less money tight up for storage - less administration</li> <li><b>4. Ecological:</b> Reduced packaging volume and waste - easy disposal</li> </ol> <p><b>Components:</b></p> <ul style="list-style-type: none"> <li>- Intrafix „M“ special administration kit 150 cm</li> <li>- Combitrans® flush device 3ml/h</li> <li>- Combitrans® disposable transducer</li> <li>- Discofix three-way stopcock, red</li> <li>- Discofix three-way stopcock, white</li> <li>- Combidyn® pressure tubing, red, 1.5 x 2.7 x 300 mm</li> <li>- fixation tape 1.5 cm x 40 cm, velcro</li> </ul> <p><b>Combitrans® Monitoring Kit „Fixation tape“</b> Monitoring kit to fix the transducer at the patient's arm. High pressure transmission due to short pressure tubing</p> <ul style="list-style-type: none"> <li>- easy patient care, especially in intensive care units due to a short and direct connection between transducer and puncture site</li> <li>- high transmission of pressure signal</li> <li>- less dead volume in the pressure tubing</li> <li>- less tubing in working area</li> </ul>	5216200	20

# Combitrans® Special

Monitoring kits with disposable transducer Customized kit solutions

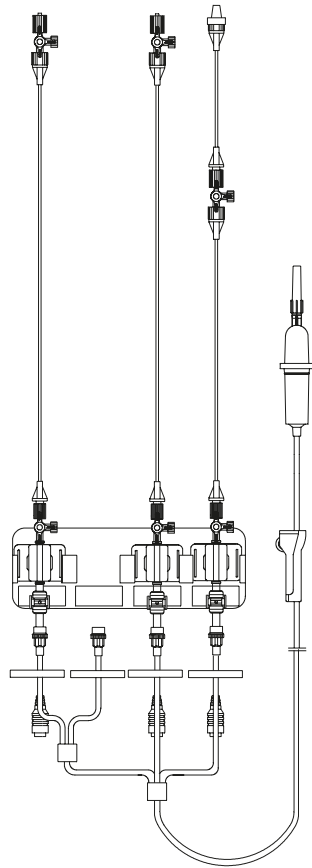

## Combitrans® Monitoring Double Kit (without illustration)

- Intrafix special administration kit, double
- two Combitrans® disposable transducers with flush device 3 ml/h and Discofix three-way stopcock (red and blue)
- two Combidyn® pressure tubing 125 cm (red and blue)
- two Discofix three-way stopcocks (red and blue)
- Combidyn® 20 cm red as arterial extension

## Combitrans® Monitoring Double Kit (without illustration)

without attachment plate

**5201152**

20

with attachment plate

**5200830**

20

## Combitrans® Monitoring Triple Kit (without illustration)

Same as Combitrans® monitoring double kit but with

- Intrafix special administration kit, triple
- additional Combitrans® disposable transducer with flush system and Discofix three-way stopcock yellow
- Combidyn® pressure tubing 125 cm yellow connected with Discofix three-way stopcock yellow
- mounted on a quadruple plate

Combitrans® Monitoring triple kit (without illustration)

**5200849**

20

# Combitrans<sup>®</sup> / Intrafix M

Disposable transducer/Infusion device

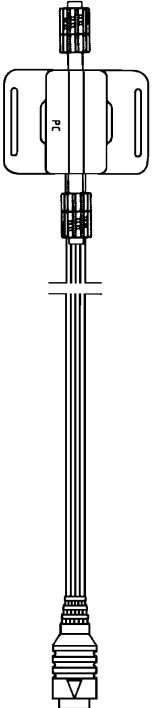
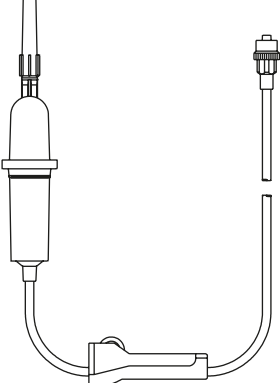
	Combitrans <sup>®</sup>	Code- Number	Sales unit-pcs.
	<p>Disposable transducer for physiological pressure measurement</p> <ul style="list-style-type: none"> <li>- compact unit with excellent pressure transmission</li> <li>- can be used in combination with all CF-class monitors</li> <li>- adapts to interface cable with plug connection</li> <li>- modern chip technology for an accurate registration of values</li> <li>- precalibrated sensor with constant electrical parameters (sensitivity, linearity, zero stability)</li> <li>- straight fluid channel for an easy air-bubble free filling</li> </ul> <p>Combitrans<sup>®</sup> disposable transducer</p>	<p><b>5203660</b></p>	<p><b>20</b></p>
	<p><b>Intrafix M</b></p> <ul style="list-style-type: none"> <li>- special administration kit for pressure measurements</li> <li>- plastic spike in accordance with ISO</li> <li>- dropper in accordance with DIN 58362-1, 20 drops = 1 ml ± 0.1</li> <li>- flexible lower section of drip chamber permits rapid adjustment of fluid level</li> <li>- 15 µm fluid filter in accordance with DIN 58362/1</li> <li>- tubing length approx. 150 cm</li> <li>- roller clamp</li> <li>- lock-fitting</li> </ul> <p>Intrafix M</p>	<p><b>40700380</b></p>	<p><b>100</b></p>

# Haemofix®-Combitrans®

Monitoring kit with disposable transducer for closed blood-sampling

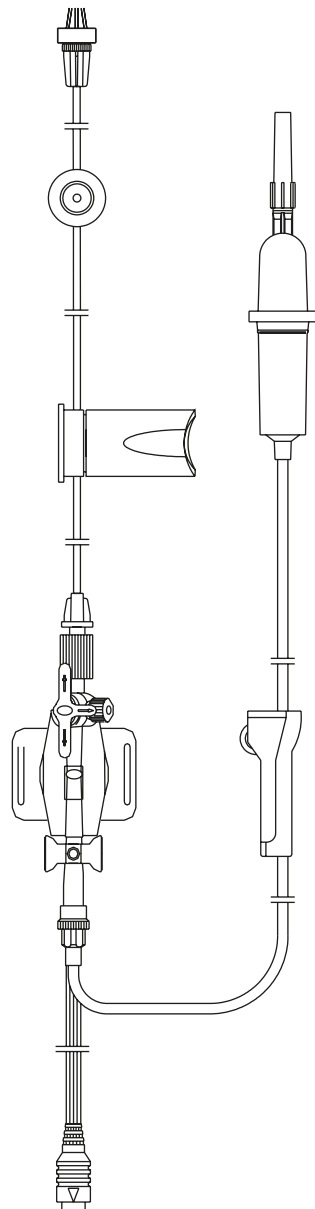

## Haemofix®-Combitrans®

Code-  
Number

Sales  
unit-pcs.

Monitoring kit with disposable transducer for physiological pressure measurement and closed blood sampling

### Complete System

- integrated reservoir and port for closed blood sampling
- high accuracy for blood gas analysis and low risk of contamination is achieved with minimum blood waste
- time reducing

### Haemofix®-Combitrans® Monitoring Kit

- Intrafix „M“ administration kit
- Combitrans® flush device 3ml/h
- Combitrans® disposable transducer
- Discofix three-way stopcock, red
- Combidyn® pressure tubing 1.5 x 2.7 x 1800 mm red with integrated Haemofix® reservoir 5 ml (20 cm prior to transducer) and blood sampling port (30 cm prior to distal end)

Haemofix®-Combitrans® Monitoring Kit

**5213505**

20

### Haemofix®-Exadyn Monitoring Kit (without illustration)

Same configuration as 5213505 but with the option to switch between arterial pressure and CVP.

### Additional components:

- Exadyn special 90° stopcock
- Combidyn® pressure tubing 1.5 x 2.7 x 1500 mm, blue
- Discofix three-way stopcock, blue

Haemofix®-Exadyn Monitoring Kit (without illustration)

**5213516**

20

### Haemofix®-Combitrans® Monitoring Kit double (without illustration)

Same configuration as 5213505 but with a second venous line, which allows the simultaneous measurement of two pressures.

### Additional components:

- Combitrans® disposable transducer with flush device 3ml/h and Discofix three-way stopcock blue
- Combidyn® pressure tubing 1.5 x 2.7 x 1500 mm, blue
- Discofix three-way stopcock, blue

Haemofix®-Combitrans® Monitoring Kit double (without illustration)

**5213527**

20

### Blood sampling adapter

- for needle-free blood sampling with blunt, concealed cannula
- single, sterile packaging
- Luer Lock

Blood sampling adapter Luer

**5213940**

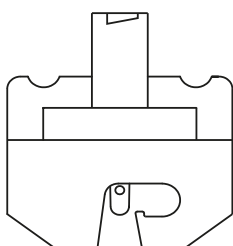

70



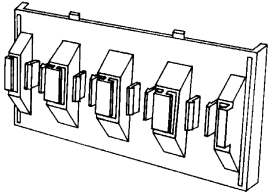
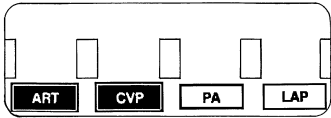
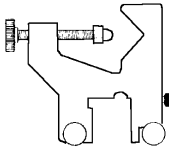

# Combitrans®

## Attachment plates/Accessories

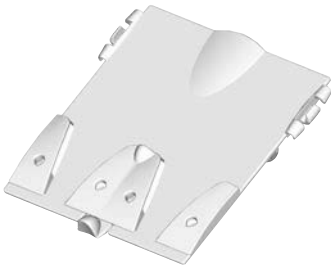
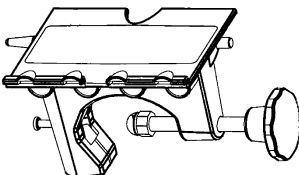
	Code- Number	Sales unit-pcs.
	<b>Combitrans® attachment plate for Siemens SC 9000</b> – exchange plate for integration into the Hemo-module of the patient monitor Siemens SC 9000 – for four Combitrans® disposable transducers	
Combitrans® attachment plate for Siemens SC 9000	<b>5208741</b>	<b>1</b>
	<b>Combitrans® attachment plate</b> – for vertical attachment to infusion stand	
Combitrans® attachment plate, quadruple	<b>5203597</b>	<b>1</b>
Combitrans® attachment plate, double	<b>5214696</b>	<b>1</b>
	<b>Combi-holder for Combitrans® attachment plate</b> – for attachment to infusion stand	
Combi-holder for Combitrans® attachment plate	<b>4086007</b>	<b>1</b>
	<b>Attachment plate quadruple</b> – special designed for the ICU (Intensive Care Unit) – click and go mechanism	
Combitrans® attachment plate ICU quadruple	<b>5215700</b>	<b>1</b>
	<b>Attachment plate double</b> – special designed for Exadyn Kits – click and go mechanism	
Combitrans® attachment plate Exadyn double	<b>5215600</b>	<b>1</b>
	<b>Attachment plate holder</b> – click and go mechanism – cable preservation – mountable in different positions	
Combitrans® attachment plate holder	<b>5215800</b>	<b>1</b>

# Combitrans® Easy Click

Monitoring kits with disposable transducer Basic kits

Combitrans® EC	Code-Number	Sales unit-pcs.
----------------	-------------	-----------------

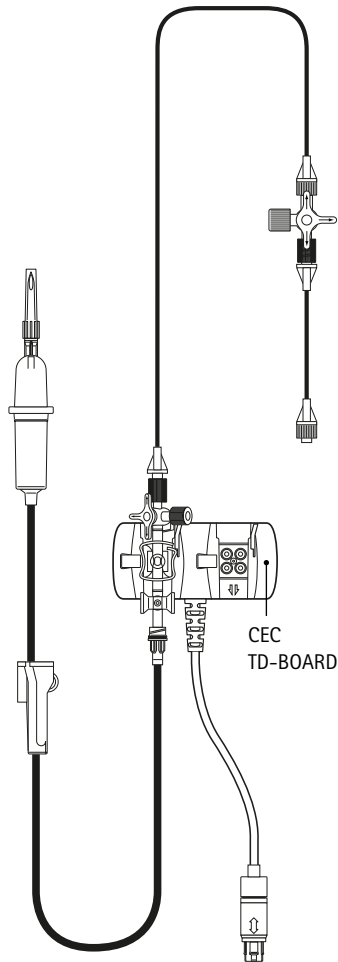

## Complete system

- for high transmission of pressure signal
- Easy click design
- time reducing
- avoids contamination at connections and during blood sampling

## Combitrans® EC Monitoring Kit

- **Intrafix® M**
  - special giving kit for pressure measurement
- **Combitrans® flush device**
  - quick flush rate  $\geq 1$  ml/s
  - continuous flush rate 3 ml/h at 300 mmHg
- **Combitrans® EC disposable transducer**
  - compact and 100 % tested unit with excellent pressure transmission
  - can be used in combination with all CF-class monitors
  - modern chip technology for an accurate registration of values
  - precalibrated sensor with constant electrical parameters (sensitivity, linearity, zero stability)
  - straight fluid channel for an easy air-bubble free filling
  - cableless transducer subassembly
- **Discofix®-3**
  - 2 three-way stopcocks red (arterial), blue (venous) or yellow (pulmonal arterial)
- **Combidyn® pressure tube 125 cm**
  - $\varnothing 1.5 \times \varnothing 2.7$  mm
  - with red (arterial), blue (venous) or yellow (pulmonal arterial) stripe
- **Combidyn® pressure tube 20 cm**
  - $\varnothing 1.5 \times \varnothing 2.7$  mm
  - with red (arterial) stripe, blue (venous) or yellow (pulmonal arterial) stripe

## Combitrans® EC Monitoring Kit

red (arterial)	<b>5319289</b>	20
blue (venous )	<b>5319290</b>	20

# Exadyn-Combitrans® Easy Click

Monitoring sets with disposable transducer

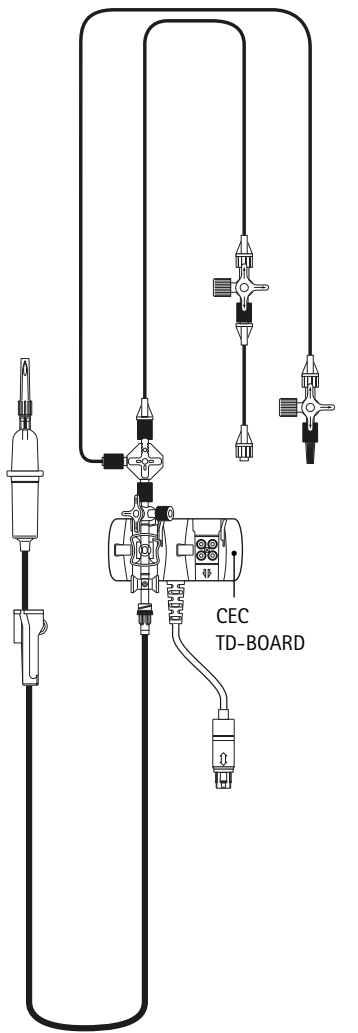
Exadyn-Combitrans® EC	Code-Number	Sales unit-pcs.	
	<p>Monitoring kit with disposable transducer for measurement of arterial pressure and CVP</p> <p><b>Complete system</b></p> <ul style="list-style-type: none"> <li>- for high transmission of pressure signal</li> <li>- time reducing</li> </ul> <p><b>Exadyn-Combitrans® EC Monitoring kit</b></p> <ul style="list-style-type: none"> <li>▪ <b>Intrafix® M</b> <ul style="list-style-type: none"> <li>- special giving kit for pressure measurement</li> </ul> </li> <li>▪ <b>Combitrans® flush device</b> <ul style="list-style-type: none"> <li>- quick flush rate <math>\geq 1</math> ml/s</li> <li>- continuous flush rate 3 ml/h at 300 mmHg</li> </ul> </li> <li>▪ <b>Combitrans® EC disposable transducer</b> <ul style="list-style-type: none"> <li>- compact and 100 % tested unit with excellent pressure transmission</li> <li>- can be used in combination with all CF-class monitors</li> <li>- modern chip technology for an accurate registration of values</li> <li>- precalibrated sensor with constant electrical parameters (sensitivity, linearity, zero stability)</li> <li>- straight fluid channel for an easy air-bubble free filling</li> <li>- cableless transducer subassembly</li> </ul> </li> <li>▪ <b>Discofix®-3</b> <ul style="list-style-type: none"> <li>- 2 three-way stopcocks red handle (arterial)</li> <li>- 1 three-way stopcock blue handle (venous)</li> </ul> </li> <li>▪ <b>Combidyn® pressure tube 125 cm</b> <ul style="list-style-type: none"> <li>- <math>\varnothing 1.5 \times \varnothing 2.7</math> mm</li> <li>- with red (arterial) or blue (venous) stripe</li> </ul> </li> <li>▪ <b>Combidyn® pressure tube 20 cm</b> <ul style="list-style-type: none"> <li>- <math>\varnothing 1.5 \times \varnothing 2.7</math> mm</li> <li>- with red (arterial) stripe</li> </ul> </li> <li>▪ <b>Exadyn special 90° stopcock</b> <ul style="list-style-type: none"> <li>- 90° two-way safety stopcock for switch over between arterial and venous measurement</li> </ul> </li> </ul> <p><b>EXADYN-Combitrans® EC Monitoring Kit</b></p> <p>Combitrans® EC Exadyn Monitoring Kit (arterial + venous pressure)</p>	<p>5318575</p>	<p>20</p>



# Combitrans® EC Special

Monitoring kit with disposable transducer

	Code- Number	Sales unit-pcs.
<p><b>Combitrans® EC Monitoring Double Kit</b></p> <ul style="list-style-type: none"> <li>- Intrafix® special giving kit, double</li> <li>- two CombitransEC disposable transducer assemblies with flush device 3 ml/h and Discifix® three-way stopcock (red and blue)</li> <li>- two Combidyn® pressure tubes 150 cm (red and blue)</li> <li>- two Discifix® three-way stopcocks (red and blue)</li> <li>- Combidyn® 20 cm red as arterial extention</li> </ul>		
Combitrans® EC Monitoring double kit – red/blue	<b>5318762</b>	20
<p><b>Combitrans® EC Monitoring Triple Kit (no illustration)</b> Same as Combitrans® EC monitoring double kit but with</p> <ul style="list-style-type: none"> <li>- Intrafix® special giving kit, triple</li> <li>- additional Combitrans® disposable transducer with flush system and Discifix® three-way stopcock yellow</li> <li>- Combidyn® pressure tube 125 cm yellow</li> </ul>		
Combitrans® EC Monitoring triple kit – red/blue/yellow	<b>5318768</b>	20
<p><b>Combitrans® EC Monitoring Set 3 Plus</b> Same as Combitrans® EC monitoring double set but with</p> <ul style="list-style-type: none"> <li>- Intrafix special giving set, quadruple, for additional transducer</li> <li>- 3 Combitrans® disposable transducers with flush device 3ml/h and Discifix® three-way stopcock (red, blue and white)</li> <li>- 3 Combidyn® pressure tubes 200 cm (red, blue)</li> </ul>		
Combitrans® EC Monitoring triple plus kit – red/blue/yellow	<b>5318766</b>	20
<p><b>Combitrans® EC Monitoring Kit Add-On</b> Additional set for Monitoring Kit 2 Plus and 3 Plus</p> <ul style="list-style-type: none"> <li>- Combitrans® disposable transducer with flush device 3ml/h</li> <li>- Discifix® three-way stopcock white</li> <li>- Combidyn® pressure tubing 125 cm transparent</li> </ul>		
Combitrans® EC Monitoring single kit ADD ON	<b>5318776</b>	20

# Combitrans® EC

## Transducer Boards/ Holder/Accessories

	Code- Number	Sales unit-pcs.	
	<b>Transducer Boards</b> with standard hub		
	CEC TD-BOARD, 1-fold	5225000	1
	CEC TD-BOARD, 2-fold	5225005	1
	CEC TD-BOARD, 3-fold	5225010	1
	CEC TD-BOARD, 4-fold	5225015	1
	<b>Transducer Boards</b> with integrated monitor hub		
	CEC TD-BOARD Hemopod, 2-fold	5225040	1
	CEC TD-BOARD Hemopod, 4-fold	5225045	1
	CEC TD-BOARD DRÄGER 10, 2-fold	5225020	1
	CEC TD-BOARD DRÄGER 10, 4-fold	5225025	1
	CEC TD-BOARD Med. Physio Contr., 1-fold	5225030	1
	CEC TD-BOARD Datascop IABP, 1-fold	5225035	1
	<b>Connection Cables</b>		
CEC CABLE HP/Philips 2-fold	5225050	1	
CEC CABLE HP/Philips 3-fold	5225055	1	
CEC CABLE HP/Philips 4-fold	5225060	1	
CEC CABLE GE/Marquette 2-fold	5225065	1	
CEC CABLE GE/Marquette 3-fold	5225070	1	
CEC CABLE GE/Marquette 4-fold	5225075	1	
CEC CABLE SIEMENS10/DRÄ, 2-fold	5225080	1	
CEC CABLE SIEMENS10/DRÄ, 3-fold	5225085	1	
CEC CABLE SIEMENS10/DRÄ, 4-fold	5225090	1	
CEC CABLE SIEMENS7/DRÄ, 2-fold	5225095	1	
CEC CABLE SIEMENS7/DRÄ, 3-fold	5225100	1	
CEC CABLE SIEMENS7/DRÄ, 4-fold	5225105	1	
CEC CABLE DATEX, 2-fold	5225110	1	
CEC CABLE DATEX, 3-fold	5225115	1	
CEC CABLE DATEX, 4-fold	5225120	1	
CEC CABLE Siemens Miniograph 2-fold	5225125	1	
	<b>Holder</b>		
	Combitrans® EC Holder, unmoveable	5225135	1
<b>Accessories</b>			
Combitrans® EC Dummy (for unused transducer nest)	5310000	25	
Combitrans® EC Adapter for Hemopod	5225130	1	
Combitrans® EC Monitoring Kit for cath lab Typ Munich, arterial	5311010	1	
Combitrans® EC Monitoring Kit for cath lab Typ Munich. venous	5312020	1	
Combitrans® EC Monitoring Kit for cath lab Typ Stuttgart	5313030	1	

# Combidyn®

Monitoring kit for pressure measurement with reusable transducer

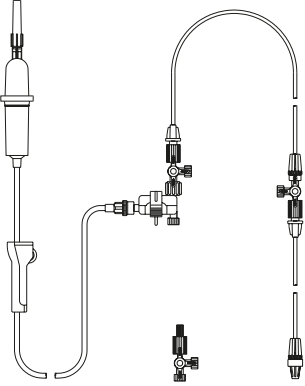
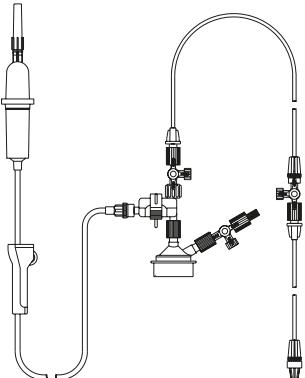
	Combidyn®	Code- Number	Sales unit-pcs.
	<p>Monitoring kit for physiological pressure measurement</p> <p><b>Complete system</b></p> <ul style="list-style-type: none"> <li>- for high transmission of pressure signal</li> <li>- time reducing</li> <li>- avoids contamination at connections and during blood sampling</li> </ul> <p><b>Combidyn® Monitoring kit</b> Basic kit, without pressure dome</p> <ul style="list-style-type: none"> <li>▪ <b>Intrafix M</b> - special administration kit for pressure measurement</li> <li>▪ <b>Combidyn® flush device</b> - quick flush rate – continuous flush rate 3 ml/h at 300 mmHg</li> <li>▪ <b>Discofix-3</b> - three-way stopcock, red</li> <li>▪ <b>Combidyn® pressure tubing 125 cm</b> - ø 1.5 x ø 2.7 mm - with red stripes</li> <li>▪ <b>Combidyn® pressure tubing 20 cm</b> - ø 1.5 x ø 2.7 mm - with red stripes</li> </ul>		
	<p><b>Combidyn® Monitoring Kit</b> Basic kit, with pressure dome - Same configuration as above, but with pressure exchanging dome</p>		
	Combidyn®	<b>5206502</b>	25
	Reusable Transducer/Disposable domes/Flush device	<b>5207410</b>	25
	for SensoNor 840 transducers	<b>5207070</b>	25
	for Hewlett Packard 1295 C transducers		

# Combidyn®

## Reusable Transducer/Disposable domes/Flush device

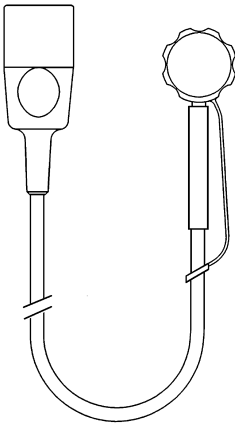
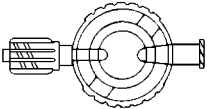
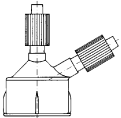
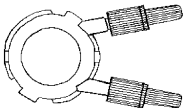
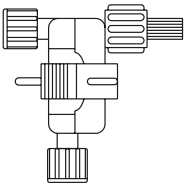
	SensoNor 844	Code-Number	Sales unit-pcs.
	<p>Reusable physiological pressure transducer</p> <ul style="list-style-type: none"> <li>- highly accurate and robust piezoresistive transducer</li> <li>- easy handling</li> <li>- click and go fixing</li> <li>- cable length 3 m</li> <li>- dry connection from dome to sensor</li> <li>- precalibrated sensor with constant electrical parameters</li> <li>- high overload protection</li> <li>- high accuracy of measurement</li> <li>- can be used in combination with all CF-class monitors</li> <li>- gold plated for easier cleaning</li> <li>- long service life</li> </ul>		
	SensoNor 844 pressure transducer	<b>5904001</b>	<b>1</b>
	<p><b>Combidyn®</b> Disposable (single use) domes for physiological pressure measurement</p> <ul style="list-style-type: none"> <li>- diaphragm made of PUR</li> <li>- transparent</li> <li>- easily filled, without air bubbles</li> <li>- luer-fitting resp. Linden / luer-fitting</li> <li>- single sterile packed</li> </ul>		
	for SensoNor transducers 844 with stopcock (without illustration)	<b>844-31</b>	50
	for SensoNor transducers 844 with two stopcock	<b>5203320</b>	25
	for SensoNor 840 transducers	<b>5204100</b>	25
	for Gould P23 XL, P23 ID transducers and Statham	<b>5204917</b>	25
	for Hewlett Packard 1295 C transducers	<b>5207231</b>	25
	<p><b>Combidyn® flush device</b> System for arterial and venous catheter flushing</p> <ul style="list-style-type: none"> <li>- quick flush rates to fill the monitor systems or flush the catheter</li> <li>- continuous flow rate 3 ml/h at 300 mmHg</li> <li>- easy control due to rectangle test</li> <li>- transparent for visual control</li> <li>- lock-fittings</li> <li>- female/male/female</li> </ul>		
	Combidyn® flush device	<b>5201500</b>	<b>50</b>

# Combidyn®

Pressure tubings made of PVC

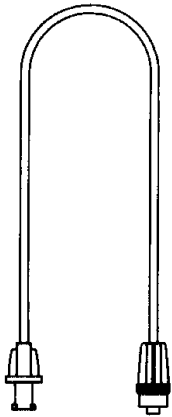

## Combidyn®

Pressure tubing for the measurement of physiological pressure

- ø 1.5 x 2.7 mm
- undamped and accurate pressure monitoring
- pressure stability tested up to 8 bar
- transparent for visual control
- tubing of various lengths
- dead space approx. 1.2 ml/m
- tube length matches practical requirements
- colour-coding:
  - red stripes (arterial)
  - blue stripes (venous)
  - yellow stripes (pulmonal arterial)

▪ **luer-fittings**

- with special screw thread
- male/female
- ABS

length	Code-Number	Sales unit-pcs.
<b>Combidyn® transparent</b>		
20	5204984	50
50	5205000	50
100	5205018	50
150	5205026	50
200	5205034	50
<b>Combidyn® transparent with red stripes</b>		
20	5204941	50
100	5204976	50
150	5205042	50
200	5205050	50
<b>Combidyn® transparent with blue stripes</b>		
100	5205255	50
150	5205263	50
200	5205271	50
<b>Combidyn® pressure tubing with three-way stopcock</b>		
- pressure tube, red, ø 1.5 mm x ø 2.7 mm, 20 cm		
- connected three-way stopcock, red		
Combidyn® pressure tubing with three-way stopcock	5208599	50

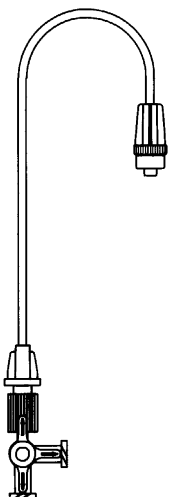



# Combidyn®

Pressure tubing made of Polyethylene Adaptor

Combidyn®	Code-Number	Sales unit-pcs.
-----------	-------------	-----------------

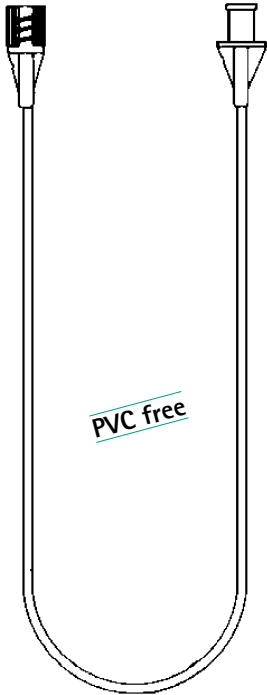

Pressure tubing for physiological pressure measurement and intravenous medications

### Combidyn® Polyethylene

- transparent Polyethylene
- especially useful for infusion of drugs with PVC-incompatibility
- pressure resistance tested up to 8 bar
- transparent for visual control
- reduced dead space
- easy handling due to flexible material
- especially for paediatric and neonatal pressure measurement
- tubing diameter  $\varnothing$  1.0 x 2.0 mm
- dead space approx. 0.8 ml/m

length	Code-Number	Sales unit-pcs.
--------	-------------	-----------------

### Combidyn® transparent

15	5204995	50
30	5214993	50
100	5215019	50
120	5201281	50
150	5215027	50
180	5201337	50
200	5215035	50
240	5201272	50

### Combidyn® transparent with red stripes

30	5204950	50
----	---------	----

### Combidyn® transparent with blue stripes

30	5205239	50
150	5215264	50

### Combidyn® pressure tubing

Pressure tubing for additional connection of a three-way stopcock with a catheter.

- pressure tubing Combidyn® PE  $\varnothing$  1.0 x 2.0 mm with blue stripes
- luer-fittings male/male

150 blue	5210577	50
----------	---------	----

### Combifix Adaptor

to connect Luer lock-fittings

female/female	5206634	100
male/male	5206642	100



# Intradyn® Venous

Introducer for anaesthesia and intensive care

Intradyn® Venous Hemostasis Introducer	Code-Number	Sales unit-pcs.
--	-------------	-----------------

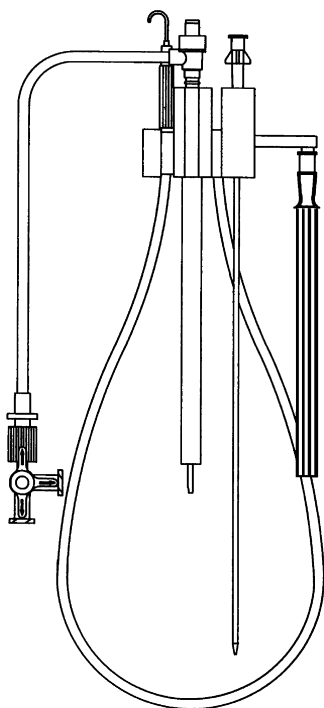

Percutaneous catheter introducer kit using the Seldinger technique according to Desilets-Hofmann

▪ **Intradyn® puncture needle, according to Seldinger, 1.3 x 70 mm (18 G)**

- stainless steel,  $\varnothing$  1.3 mm (18G)
- smoothly tapered fitting for easy introduction of the guide wire

▪ **Guide wire, 40 cm**

- stainless steel,  $\varnothing$  0.035 „/0.89 mm
- flexible straight tip

▪ **Vessel dilator, 205 mm, made of FEP**

- flexible, causing minimal trauma to vessels
- smoothly tapered transition to guide wire

▪ **Sheath, 115 mm, made of PUR**

- thin-walled
- smoothly tapered transition to vessel dilator

▪ **Hemostasis valve**

- to avoid retrograde blood flow
- for venous application
- smoothly tapered transition for easy introduction of catheter
- sideport with mounted three-way stopcock for easy administration of I.V. solutions and injection of medications
- Lock-fitting

**Intradyn® venous with hemostasis valve**

- with J3-guide wire

F6 green	<b>5209749</b>	20
F7 orange	<b>5209757</b>	20
F8 blue	<b>5209765</b>	20



**Intradyn® venous with hemostasis valve**

- with straight guide wire

F5 grey	<b>5210615</b>	20
F6 green	<b>5210062</b>	20
F7 orange	<b>5210070</b>	20
F8 blue	<b>5210089</b>	20

# Intradyn® Special

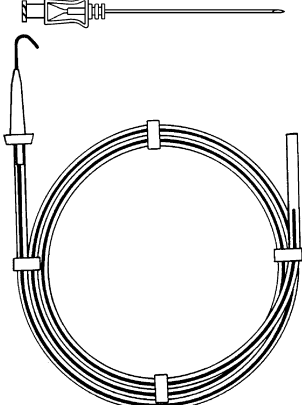
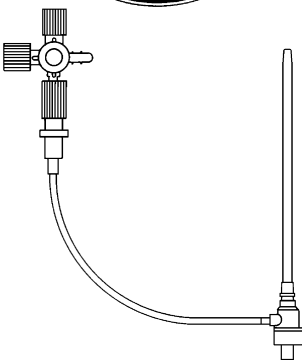
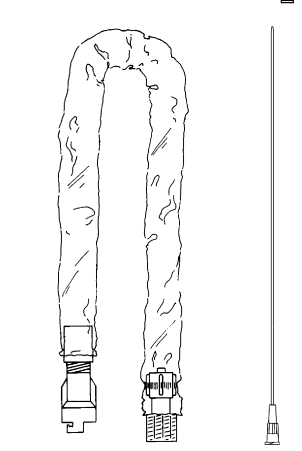
## Basic Intensive Care Kit

	Intradyn® Basic Intensive Care Kit	Code- Number	Sales unit-pcs.
	<p>Intradyn® venous, percutaneous catheter introducer kit using the Seldinger technique according to Desilets-Hofmann</p> <ul style="list-style-type: none"> <li>- Intradyn® puncture needle <math>\varnothing</math> 1.3 x 63.5 mm (18 G)</li> <li>- guide wire, 70 cm, <math>\varnothing</math> 0.035"/0.89 mm</li> <li style="padding-left: 20px;">flexible J3-tip with insertion tool or flexible straight tip</li> <li>- vessel dilatator, 205 mm made of FEP</li> <li>- venous hemostasis introducer sheath, 115 mm made of PUR</li> <li>- hemostasis valve</li> <li>- catheter contamination guard, 120 cm</li> <li>- disposable scalpel</li> <li>- 4 gauze pads, 10 x 10 cm, eight-ply</li> </ul>		
	<p>Intradyn® basic kit F6</p>	<p><b>5210950</b></p>	<p>10</p>
	<p>Intradyn® basic kit F7</p>	<p><b>5210100</b></p>	<p>10</p>
	<p>Intradyn® basic kit F8</p>	<p><b>5210097</b></p>	<p>10</p>
	<p>Intradyn® basic kit F9</p>	<p><b>5210674</b></p>	<p>10</p>

# Intradyn® Special

## Complete Intensive Care Kit

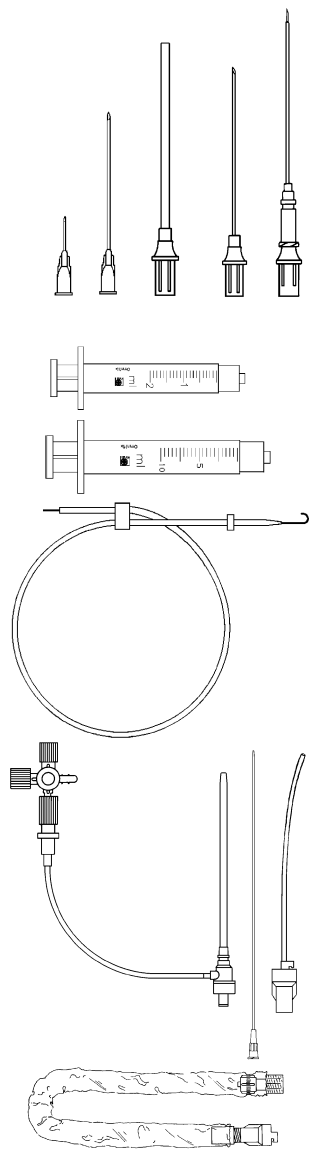

### Intradyn® Complete Intensive Care Kit, F8

Code-  
Number

Sales  
unit-pcs.

- disposable injection cannula 0.51 x 15.9 mm (25 G)
- disposable injection cannula 0.72 x 38.1 mm (22 G)
- insertion needle, 1.235 x 63.5 mm (18 G)
- radio-opaque venous catheter introducer cannula made of FEP, 1.24 x 63.5 mm (18G)
- 3 ml and 5 ml syringe (Luer-fitting)
- guide wire, 45 cm,  $\varnothing$  0.035/0.89 mm with flexible J-tip with insertion tool or flexible straight tip
- disposable scalpel
- straight needle (23/8", 6 cm) with silk suture (75 cm, 30")
- 2 x 2 gauze pads
- 4 x 4 gauze pads
- fenestrated drape
- filter straw (13/4", 4.4 cm)
- F8 venous hemostasis introducer sheath, 115 mm, made of PUR, with hemostasis valve and sideport with tubing and three-way stopcock
- F8 vessel dilator 205 mm
- catheter contamination guard (120 cm)
- obturator F8, PUR mandrel to close the sheath

### Intradyn® Complete Intensive Care Kit

F8

5210003

10

#### Create your individual Intradyn® Intensive Care Kit

Customized and user-friendly solutions are combined with economical and ecological advantages:

#### 1. Service through sales representative:

Demand analysis - kit proposal - sample and customized kit configuration according to your requirements - offer

#### 2. Individual and user-friendly:

Your made-to-order solution out of our large B. Braun range - reduction of preparation time - designed and packaged due to customer specification - one order number

#### 3. Economical:

Standardization of work practices - relief of clinic personnel - easy material management - less money tight up for storage - less administration

#### 4. Ecological:

Reduced packaging volume and waste - easy disposal

# Intradyn®

## Accessories

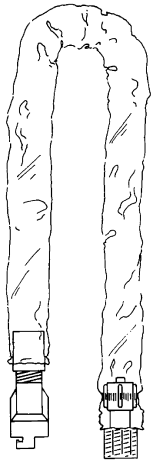

### Catheter contamination guard for Intradyn® hemostasis introducer sheath

- proximal: fitting for safe fixation of the catheter or probe
- transparent contamination guard for visual control prevents contamination of catheters and probes during their introduction
- special connection to the sheath due to bayonet locking, 120 cm

	Code-Number	Sales unit-pcs.
Catheter contamination guard	5210178	50

### Intradyn® guide wires (ø 0.035"/0.89mm) (without illustration)

J3-tip with straightener in dispenser	5050529	25
---------------------------------------	---------	----

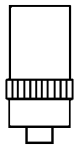

### Haemostop

Hemostasis valve for insertion of catheters and probes combined with, e. g. Intradyn® venous without hemostatic valve

- avoids blood leakage
- smooth introduction of catheters and probes
- no closing cone
- Luer Lock-fitting
- valve for arterial and venous use
- continuous hemostasis

Haemostop	5209641	50
-----------	---------	----

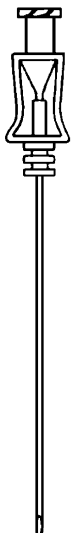

### Intradyn® arterial puncture needle (Seldinger)

- Smoothly tapered design for easy introduction of the guide wire up to max. ø 0.035" (0.089 mm)
- Luer-Lock fitting

gauge (G)	diam (mm)	length (mm)	Colour	Code-Number	Sales unit-pcs.
18	1.3	70	light pink	5208505	50

# Intradyn® Tear-Away

## Tear-Away Introducer

### Intradyn® Tear-Away

Code-  
Number

Sales  
unit-pcs.

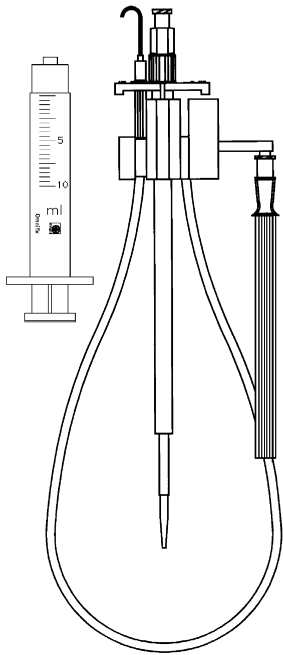

Tear-Away introducer sheath using the Seldinger technique according to Desilets-Hofmann  
 – the pre-scored tearing line ensures a clean and easy sheath removal after catheter placement  
 – the spin-lock connector holds dilatator and sheath together, preventing dilatator from backing out of sheath during vascular access

### Intradyn® Tear-Away

- **Intradyn® puncture needle according to Seldinger 1.3 x 70 mm (18 G)**
  - made of stainless steel
  - smoothly tapered hub transition for easy introduction of guide wire
- **Guide wire 40 cm**
  - made of stainless steel,  $\varnothing$  0.035" / 0.89 mm
  - flexible J3-tip and flexible straight tip
- **Vessel dilatator, 190 mm made of PE**
  - flexible, minimal trauma to vessels
  - smoothly tapered transition to guide wire
- **Introducer sheath, 160 mm made of FEP- thin-walled**
  - smoothly tapered transition to vessel dilatator
- **Syringe Luer lock-fitting 10 ml**

### Intradyn® Tear-Away Introducer

F6	5210313	20
F7	5210593	20
F8	5210321	20
F9	5210330	20
F10	5210348	20
F11	5210585	20

### Intradyn® dual Tear-Away Introducer

Splittable introducer set with two sheaths for the introduction of two probes for VDD- and DDD-pacemaker

Same content as Intradyn® Tear-Away, however with two introducer sheaths and two dilatators

### Intradyn® dual Tear-Away Introducer

F10	5212537	20
-----	---------	----

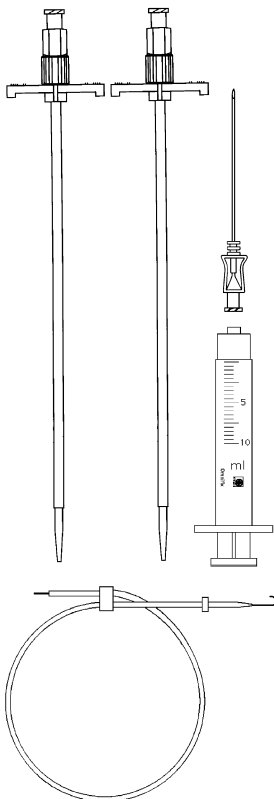

# Arteriofix

## Arterial catheter kits

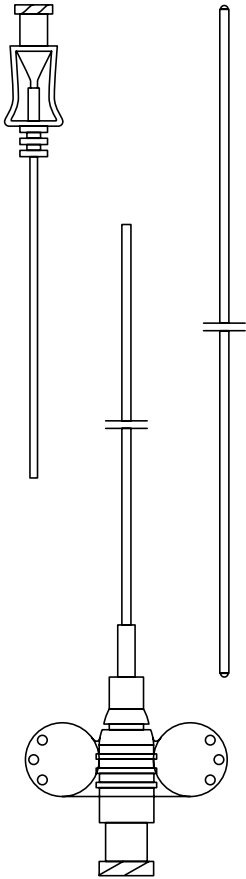

### Arteriofix

Arterial catheter kit for invasive monitoring of blood pressure and blood sampling using the Seldinger technique

- **Introducer needle** made of stainless steel
  - smoothly tapered hub transition for easy insertion of guide wire
  - integrated design, providing smooth transition from guide wire to needle and needle to catheter to ensure minimal trauma at puncture site
  - Luer lock fitting
- **Catheter** made of FEP
  - for pressure transmission and good physical and mechanical properties of the material
  - excellent tissue and blood compatibility
  - smooth surface prevents thrombogenesis
  - special tip for easy insertion
  - FEP catheters have good gliding characteristics during insertion
  - fixation wings at proximal end
  - colour-coded Luer lock-fittings
- **Guide wire** made of stainless steel
  - flexible straight tip
  - designed according to the different inner diameters of catheters

colour	size	capillary: mm [Ø]; length [mm]	needle: Ø [G; mm]; length [mm]	wire: length [cm] - Ø [Inch]	Code- Number	Sales unit-pcs.
<b>Ateriofix Catheter kits</b>						
yellow	22G/ 80 mm	0.87; 80	22; 0.80 x 50	25-0.021	<b>5206316</b>	20
red	20G/ 80 mm	1.08; 80	20; 0.95 x 50	25-0.025	<b>5206324</b>	20
white	20G/160 mm	1.08; 160	20; 0.95 x 70	40-0.025	<b>5206332</b>	20
grey	18G/160 mm	1.29; 160	18; 1.30 x 70	40-0.035	<b>5206359</b>	20

# Arteriofix V

## Arterial catheter kits

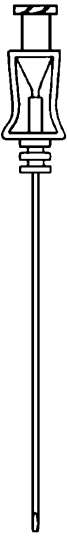
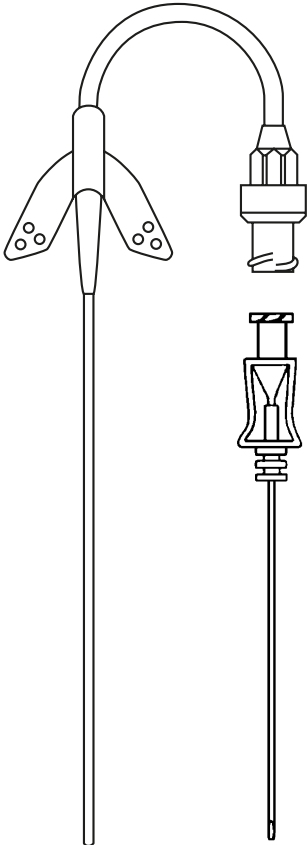
	Arteriofix V	Code-Number	Sales unit-pcs.		
	<p>This new version of Arteriofix® convinces with its outstanding new features and with established components.</p> <p><b>Catheter, consisting of:</b></p> <ul style="list-style-type: none"> <li>▪ <b>Capillary</b> <ul style="list-style-type: none"> <li>- made of FEP</li> <li>- excellent tissue and blood compatibility</li> <li>- smooth surface prevents thrombogenesis</li> <li>- special tip for easy insertion</li> <li>- outstanding gliding characteristics during insertion</li> </ul> </li> <li>▪ <b>Fixation wings</b> <ul style="list-style-type: none"> <li>- wings made of PUR</li> <li>- soft wings adapt easily to the skin</li> <li>- three suture holes</li> <li>- continuous and smooth transition between wings and capillary</li> </ul> </li> <li>▪ <b>Connecting tubing</b> <ul style="list-style-type: none"> <li>- 7 cm long PUR tubing</li> <li>- distance between puncture site and the connection area</li> <li>- strain relief at the puncture site during connection</li> </ul> </li> <li>▪ <b>Valve</b> <ul style="list-style-type: none"> <li>- avoids blood reflux and facilitates the handling</li> <li>- provides a high leak tightness</li> <li>- does not affect the pressure measurement results</li> </ul> </li> </ul>				
	<p><b>Introducer needle made of stainless steel</b></p> <ul style="list-style-type: none"> <li>- smoothly tapered hub transition for easy insertion of guide wire</li> <li>- integrated design, providing smooth transition from guide wire to needle and needle to catheter to ensure minimal trauma at puncture site</li> <li>- Luer Lock fitting</li> </ul> <p><b>Guide wire made of stainless steel</b></p> <ul style="list-style-type: none"> <li>- flexible straight tip</li> <li>- designed according to the different inner diameters of catheters</li> </ul>				
size	capillary: mm [Ø]; length [mm]	needle: Ø [G; mm]; length [mm]	wire: length [cm] - Ø [Inch]	Code-Number	Sales unit-pcs.
<b>Arteriofix V Catheter kits</b>					
22G/ 80 mm	0.87; 80	22; 0.80 x 50	35-0.021	<b>5206364</b>	20
20G/ 80 mm	1.08; 80	20; 0.95 x 50	35-0.025	<b>5206363</b>	20
20G/160 mm	1.08; 160	20; 0.95 x 70	45-0.025	<b>5206362</b>	20
18G/160 mm	1.29; 160	18; 1.30 x 70	45-0.035	<b>5206361</b>	20



# Combitrans®

## Combitrans®-Monitoring-Cables

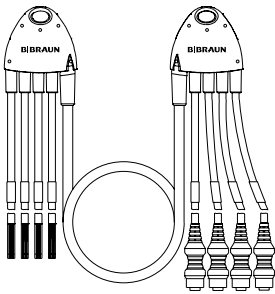
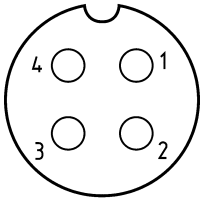

### Connection cables

- to connect Combitrans® disposable transducers with patient monitors (CF-class)
- internal adaption to monitor specification
- length 3 m

### Transducer plug /colours monitor cable

- PIN 1 = -UB (white)
- PIN 2 = + Signal (green)
- PIN 3 = + UB (yellow)
- PIN 4 = -Signal (grey)









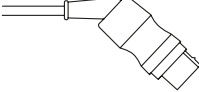

### Cable Management

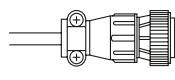
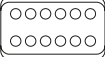
- safe and compact
- easy to clean
- simplify your cable management
- available as double, triple and quadruple

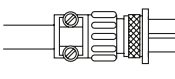
plug details	picture of plug	monitor model	Pins	Code-Number	length
<b>CABLE MANAGEMENT</b>					
		Combitrans®-Cable-Datascope double	6	<b>5203467</b>	3.0 m
		Combitrans®-Cable-Datascope triple	6	<b>5203477</b>	3.0 m
		Combitrans®-Cable-Datascope quadruple	6	<b>5203487</b>	3.0 m
		Combitrans®-Cable-Datex double	10	<b>5203424</b>	3.0 m
		Combitrans®-Cable-Datex triple	10	<b>5203434</b>	3.0 m
		Combitrans®-Cable-Datex quadruple	10	<b>5203444</b>	3.0 m
		Combitrans®-Cable-HP double	12	<b>5205422</b>	3.0 m
		Combitrans®-Cable-HP triple	12	<b>5206433</b>	3.0 m
		Combitrans®-Cable-HP quadruple	12	<b>5207440</b>	3.0 m
		Combitrans®-Cable-Marquette double	11	<b>5202422</b>	3.0 m
		Combitrans®-Cable-Marquette triple	11	<b>5202433</b>	3.0 m
		Combitrans®-Cable-Marquette quadruple	11	<b>5202444</b>	3.0 m
		Combitrans®-Cable-Spacelab double	6	<b>5209222</b>	3.0 m
		Combitrans®-Cable-Spacelab triple	6	<b>5209233</b>	3.0 m
		Combitrans®-Cable-Spacelab quadruple	6	<b>5209244</b>	3.0 m
		Combitrans®-Cable-Siemens double	10	<b>5203270</b>	3.0 m
		Combitrans®-Cable-Siemens triple	10	<b>5203280</b>	3.0 m
		Combitrans®-Cable-Siemens quadruple	10	<b>5203290</b>	3.0 m

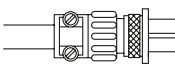

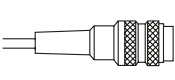

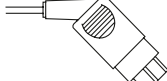



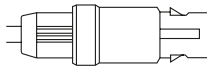

# Combitrans®

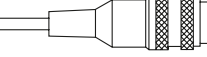
## Combitrans®-Monitoring-Cables

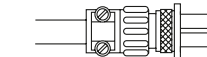
plug details	picture of plug	monitor model	Pins	Code-Number	length
	(no illustration)	<b>ACTA GRAPH</b> Polygraph	7	<b>5209234</b>	3.0 m
		<b>ARROW</b> IABP ACAT-1 Kontron Stecker Kwat II Plus	12 12	<b>5203408</b> <b>5202337</b>	3.0 m 3.0 m
		<b>BARD</b> EPU Appliance 1344; LAB-System ECG / PR-200847 (Insertion)	8	<b>5212542</b>	3.0 m
		<b>B. Braun</b> VISICON IBP supply for CombiCable CC M010; M011; M111; M211	12	<b>8732582</b>	1.5 m
		<b>BCI</b> 6200; 9100; 9200 Advisor	6	<b>5203511</b>	3.0 m
		<b>BIOMEDICAL IVY</b> 401; 402; 403; 403D; 404; 405D; 700; 701; 704; 706; 707	6	<b>5203511</b>	3.0 m
		<b>BIOTRONIK</b> EPM; HBV (20); HDR (20); Franke-Druck; MS4010; MS6010; MS8010	5	<b>5203260</b>	3.0 m
	(no illustration)	<b>BRUKER</b> SM 784; 785; 786; TM 910 Defigard 2002; Physiogard MB 910	7	<b>5209100</b>	3.0 m
		<b>CARDIO CAP</b> See Datex Engstrom	10	<b>5203414</b>	3.0 m



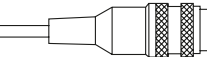

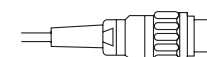
# Combitrans®

## Combitrans®-Monitoring-Cables

plug details	picture of plug	monitor model	Pins	Code-Number	length
		<b>CARDIOTEC</b> EP Tracer	9	<b>5206153</b>	3.0 m
		<b>COBE</b> CDX III	4	<b>5211670</b>	3.0 m
(no illustration)		<b>CORPULS</b> Corpuls 3	11	<b>5211468</b> + Corpuls adapter cable (04233.02)	3.0 m
Note: The Corpuls Adapter has to be ordered directly at Corpuls or an authorized distributor.					
		<b>CRITIKON</b> DINAMAP PLUS (8720; 8721; 8722) DINAMAP MPS Select / Portable	6	<b>5203511</b>	3.0 m
		<b>CRITICARE</b> Scholar 1 Modell 2200; PoetPlus	5	<b>5206152</b>	3.0 m
(no illustration)		<b>DANICA</b> Dialogue 2000	10	<b>5213363</b>	3.0 m
		<b>DANTEC</b> 21C15; 23M02; 23M04; UD5000 MK2; UD5500 MK2; Urodyne 5000; 5500; Menuet; Menuet Compact; Etude; Duet; Video	5	<b>5202825</b>	3.0 m
		<b>DATASCOPE</b> System 80; 82; 83; 84; 90; 90T; 95; 98, 97 IABP; 850; 870; P2; P3; 2000; 2000A; 2001; 2001A; 2002; x 2002A; 2200I; 3000; Passport; CS-100; CS-300	6	<b>5203457</b>	3.0 m

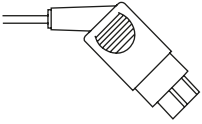
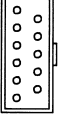
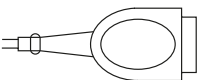

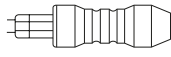
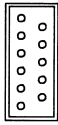
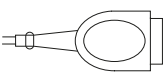
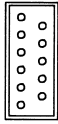
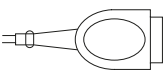

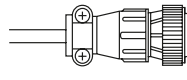



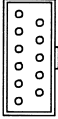
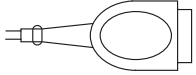

# Combitrans®

## Combitrans®-Monitoring-Cables

plug details	picture of plug	monitor model	Pins	Code-Number	length
<b>DATASCOPE / Mindray Medical Germany GmbH</b>					
<i>(no illustration)</i>		System built till 1980	6	<b>5203465</b>	3.0 m
		PM 9000 Express	6	<b>5203511</b>	3.0 m
		iPM 9800, BeneView (T5, T8)	12	<b>5203511</b> + Mindray adapter cable PN: 0010- 20-42795	
		Passport V	5	<b>5203457</b> + Mindray adapter cable PN: 040- 000096-00	
<b>DATEX</b>					
		Cardio-Cap CC-104; CCI-104; CMO-104; AS/3; CS/3; Light Cardiocap II CG-1G; S/5 light; CG-1GS; CG-2CS; CG-2G; CG-2GS; CH-1R; CH-1RS; CH-2; CH-2s; M-ESTP; M-ETP; M-P	10	<b>5203414</b>	3.0 m
		all moduls with P (e.g. E-PRESTN, E-PT, E-PP)	11	<b>5211468</b>	3.0 m
<b>DISA</b>					
<i>(no illustration)</i>		2100; 21C15	6	<b>5202833</b>	3.0 m
<b>DRAEGER</b>					
		Cato; Cicero EM; Vitara Parameterbox PB 8800; PM 8010; PM 8014; PM 8040; PM8060; Sulla; UM3; UM3.1;	7	<b>5203350</b>	3.0 m
		North American Draeger Monitor Vitalert 2000 Dash 2000/3000/4000	11	<b>5211468</b>	3.0 m
<i>(no illustration)</i>		MPod	5	<b>5203251</b>	
<i>(no illustration)</i>		Mpod - active	5	<b>5203255</b>	
<i>(no illustration)</i>		Adapter for Hämobox/HemoMed 2 channels, D-Sub-Plug	15	<b>5203399</b>	0.1 m
<b>E for M</b>					
		see Marquette PDS 300	11	<b>5211468</b>	3.0 m
<b>GE / MARQUETTE</b>					
		2000 Series 7000 Series 7010 Series (not traded anymore)	8	<b>5212430</b>	3.0 m

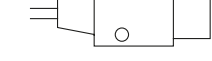

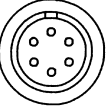
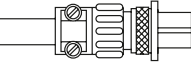

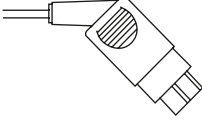
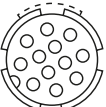
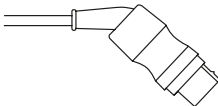
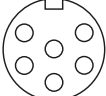
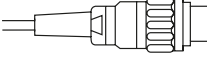







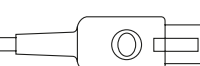

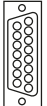
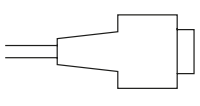

# Combitrans®

## Combitrans®-Monitoring-Cables

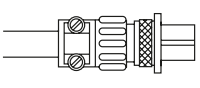
plug details	picture of plug	monitor model	Pins	Code-Number	length
		<b>GE / MARQUETTE</b>			
		Cath-Lab; MAC-Lab (general term) Tram Module 100 up to 600; Muse Solar 7000; 8000; 9000; 808; Cardio-Window Eagle/Dash 1000; 2000; 3000; 3100; 4000	11	<b>5211468</b>	3.0 m
		<b>HELLIGE</b>			
		Vicom (5. Generation) SMU 610; 611; 612; 613; 630; 639; SMK 230; 231; 260; SMU-EVO Caution: Marquette Eagle	10	<b>5201098</b>	3.0 m
		Servomed (4.Generation) SMV 104; 107; 111:	10	<b>5203295</b>	3.0 m
		SMS 104; 108; 109; 164; 168; 302; 304; 308 SMK 155			
		Midas	18	<b>5213169</b>	3.0 m
		Vicom	10	<b>5211972</b>	5.0 m
		<b>HONEYWELL</b>			
	(no illustration)	Philips Physio-Cardiopan	9	<b>5203392</b>	3.0 m
		<b>INVIVO RESEARCH</b>			
		3000; 3200; Omni-trek TVS Millennia; Omeda; 1400 Series; Expression	6	<b>5203511</b>	3.0 m
		<b>JOSTRA</b>			
	(no illustration)	HLM 20/21	5	<b>5216767</b>	3.0 m
		<b>KONE</b>			
		M560A; M565A; M575; MA544	10	<b>5203414</b>	3.0 m
		<b>KONTRON</b>			
		Minimon 7131 up to 7136: Fetalmon 2A; 2B Fetalogic 4000; Fetasonde 5; 5A; 5B; K2000 Balloon Pump; KAAT II; Module 10 up to 7286; Supermon	12	<b>5202337</b>	3.0 m
		Series 108; 200	6	<b>5203457</b>	3.0 m

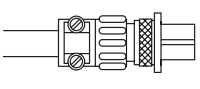

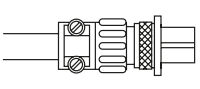
# Combitrans®

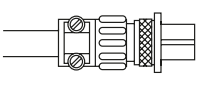
## Combitrans®-Monitoring-Cables

plug details	picture of plug	monitor model	Pins	Code-Number	length
		<b>LOHMEIER / B. BRAUN</b>			
		VISICON IBP supply for CombiCable CC M010; M011; M111; M211	12	<b>8732582</b>	1.5 m
		M6 08; M8 08; M910; PM315	12	<b>5211661</b>	3.0 m
		<b>LITTON</b>			
		see Hellige Servomed	10	<b>5203295</b>	3.0 m
		<b>MENNEN</b>			
		Horizon 1100; 2000 Series; 3000 9000 Series; XL Series	6	<b>5202876</b>	3.0 m
		EMS; ENVOY; MERCURY; SOLO; MICRO-SOLO; MR 1200 up to 9200; Cathlab	6	<b>5203511</b>	3.0 m
		ENVOY	8	<b>5202531</b> + Mennen adapter part no. 551- 360-11	3.0 m
	<i>(no illustration)</i>				
		<b>METEK</b>			
		DAVID	15	<b>5203000</b>	3.0 m
		<b>NDE</b>			
		Monitor	6	<b>5203511</b>	3.0 m
		<b>NELLCOR PURITAN BENNET</b>			
		Escort 300 A	6	<b>5203511</b>	3.0 m
		PD 240; PB 245; PB 245 P	10	<b>5209242</b>	3.0 m
		<b>NIHON KOHDEN</b>			
	<i>(no illustration)</i>	BSM 2301; BSM4101A		<b>5203201</b> + Nihon Kohden adapter cable (K952)	
		<b>MEDTRONIC / PHYSIO CONTROL</b>			
		VSM-1; VSM-4A; VSM-5	6	<b>5202485</b>	3.0 m
		Lifepak 12; Lifepak 15	6	<b>5203449</b>	3.0 m



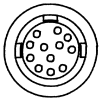
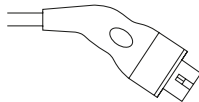
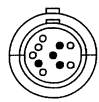
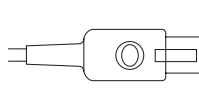
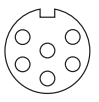
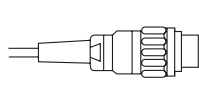
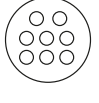
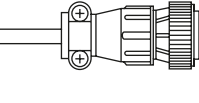
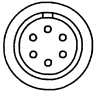
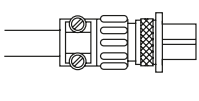
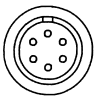
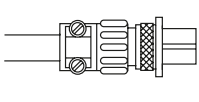
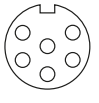
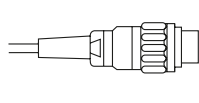

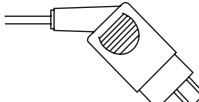
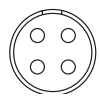
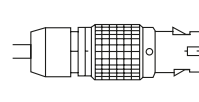





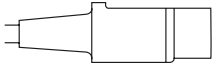

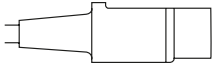

# Combitrans®

## Combitrans®-Monitoring-Cables

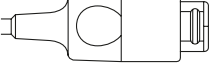
plug details	picture of plug	monitor model	Pins	Code-Number	length
		<b>PHILIPS / HEWLETT PACKARD</b>			
	(no illustration)	B series Philips MX700/800	12	<b>5203406</b>	3.0 m
	(no illustration)	A series	12	<b>5213080</b>	3.0 m
	(no illustration)	B series Intellivue MP70	12	<b>5202850</b>	3.0 m
	(no illustration)	<b>POLYGRAPH</b>			
		EP 12	8	<b>5209218</b>	3.0 m
		<b>PPG BIOMEDICAL</b>			
		see HELIGE VICOM	10	<b>5201098</b>	3.0 m
		<b>PRUCKA</b>			
		CLAB I (see Datascope)	6	<b>5203457</b>	3.0 m
		CLAB II	8	<b>5203460</b>	3.0 m
		<b>PROTOCOL</b>			
		Propaq 104; 106; 206; 204 Encore; welchallyn; Zoll	6	<b>5203449</b>	3.0 m
		<b>PURITAN BENNET</b>			
		PB 224; 240; 245	6	<b>5203511</b>	3.0 m
		<b>ROCHE</b>			
		220; 222; 223; 224; 7320; 7324	6	<b>5203457</b>	3.0 m
		<b>S&amp;W (SIMSON &amp; WEIL)</b>			
		System 8000 Athena; 8041; Diascope 2; Diascope Traveler; Diascope NT	10	<b>5203430</b>	3.0 m
		<b>SARNS / 3M</b>			
		5000; 8000; 8595; 9000 HLM; System 1	5	<b>5209226</b>	3.0 m
	(no illustration)	<b>SCHWARZER PICKER</b>			
		DME 48	12	<b>5203546</b>	3.0 m

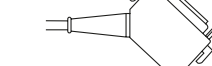
# Combitrans®



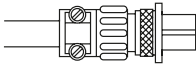







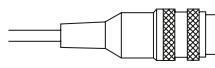

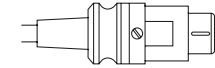



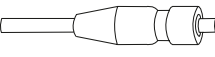

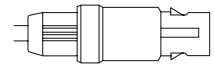
## Combitrans®-Monitoring-Cables

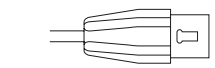
plug details	picture of plug	monitor model	Pins	Code-Number	length
<b>SIEMENS / DRAEGER</b>					
		SC 6000, SC7000; Dräger Infinity Delta, Gamma, Gamma XL	7	<b>5212643</b>	3.0 m
		SC 6000 Adapter 7 to 10 Pin SC 7000	7 10	<b>5206458</b>	0.2 m
		Sirecust 400-1281; SC 8000; Dräger Infinity Kappa Cable for Siemens Hemo Adapter	10	<b>5203361</b>	0.1 m
		Sirecust 400-1281; SC 8000; Dräger Infinity Kappa	10	<b>5203263</b>	1.7 m
		Sirecust 400-1281; SC 8000; Dräger Infinity Kappa	10	<b>5209250</b>	5.0 m
		Mingograph 7 (Europe); CathCor; HKL 440M; Multigraph Recor; CathLab; Micor; Cartridge; Sicor;	15	<b>5203279</b>	3.0 m
		Sirecust 400-1281; SC 8000; Dräger Infinity Kappa CrosKop X-ray system; 2002 Tochttersichtgerät	10	<b>5203252</b>	3.0 m
(no illustration)		Sirecust 300 series (342R)	5	<b>5203260</b>	3.0 m
<b>SPACELABS</b>					
		Series 400; 500; 600; 700; 1000; 3000; 90300; 90400; (90402; 90470; 90496); 90600; Alpha 7; 9; PC 1,2; UVW; 90367 portable PC Express; TEK / VIATEK; Scout	6	<b>5203511</b>	3.0 m
		Module 90496 (10 cm Adapter Cable)	10	<b>Spacelabs 700-0028-00</b>	3.0 m

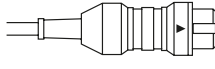

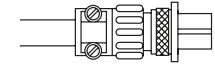
# Combitrans®

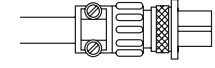
## Combitrans®-Monitoring-Cables

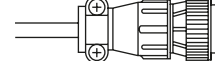
plug details	picture of plug	monitor model	Pins	Code-Number	length
		<b>STOECKERT / SORIN</b> Stoeckert HLM; CAPS Series; S5 and C5 systems	4	<b>5211670</b>	3.0 m
		<b>SCHILLER</b> Cardioswiss CM-8; TM-7 Cardiovit AT-2S Argus	5	<b>5211603</b>	3.0 m
		PB-1000 (F-Series until 2005)	4	<b>5211601</b>	3.0 m
		PB-1000 (LP-Series new generation), Argus PRO	4	<b>5211602</b>	3.0 m
		<b>SCHWARZER</b> Physioscript PD 14 (since 9/98) Cardis 5000 Neurocard Monitor	5	<b>5212846</b>	3.0 m
		Physioscript PD 14 (till 9/98) CU12-C	12	<b>5211735</b>	3.0 m
		Cardis 5000 with Philips module	12	<b>5212850</b>	3.0 m
		<b>TEKTRONIX</b> 413A; 414; 414-21	6	<b>5203511</b>	3.0 m
		<b>VIATEK</b> see Spacelab	6	<b>5203511</b>	3.0 m
		<b>WITT</b>	8	<b>5209500</b>	3.0 m

Customized devices on request. Please ask your clinical specialist.

# Conversion tables

Pressure units	bar	mm Hg	cm H2O	atm	psi	kPa
1 bar =	1	736	1019	0.987	14.51	100
1 mm Hg =	0.0013	1	1.39	0.0013	0.02	0.133
1 cm H2O =	9.81*10 <sup>-4</sup>	0.736	1	0.0013	0.019	0.0981
1 atm =	1.013	745	1033	1	14.69	101.3
1 psi =	0.0689	50.71	70.21	0.068	1	6.89
1 kPa =	0.01	7.501	10.19	0.0099	0.145	1

## Metal cannula

Gauge	Nominal outer diameter in mm*	acc. to ISO 6009 colour code for injection cannulas
30	0.3	yellow
28	0.36	blue-green
26	0.45	brown
24	0.55	pink
22	0.7	black
20	0.9	yellow
18	1.2	rose
16	1.6	white
14	2.1	white-green
12	2.7	white-blue

\*) according to ISO/DIN 9626

## Catheter diameter 1 F = 1/3 mm

French (F)	1	2	3	4	5	6	7	8	9	10	11	12	14
mm	0.33	0.67	1.0	1.33	1.67	2.0	2.33	2.67	3.0	3.33	3.67	4.0	4.67

## Wire diameter 1" = 25.4 mm

Inch (")	0.008	0.010	0.014	0.018	0.024	0.028	0.032	0.035	0.038	0.045	0.047	0.063	0.071
Fmm	0.20	0.25	0.36	0.46	0.61	0.71	0.81	0.89	0.97	1.14	1.19	1.60	1.80

## Catheter length 1 foot = 30.5 cm

Feet	1	2	3	4	5	6
cm	30.5	61.0	91.4	1.22	1.52	1.83

# Notice



Lined area for writing notice, consisting of 20 horizontal lines.

# Notice



A series of horizontal lines for writing, consisting of 25 evenly spaced lines.

# Notice



A series of horizontal lines for writing, consisting of 23 lines spaced evenly down the page.

# B. Braun Vascular Systems

## EUROPE

### AUSTRIA

**B. Braun Austria GmbH**

Otto Braun - Straße 5  
2344 Maria Enzersdorf  
Phone ++43/22 36 46 54 10  
Fax ++43/22 36 4 84 79

### BELGIUM

**B. Braun Medical N. V./S. A.**

Woluwelaan 140 b  
1831 Diegem  
Phone ++32 70 22 33 00  
Fax ++32 70 22 33 00

### CZECH REPUBLIC

**B. Braun Medical s. r. o.**

V Parku 2335/20  
148 00 Praha 4  
Phone ++420/2/71 091 911  
Fax ++420/2/71 091 912

### DENMARK

**B. Braun Medical A/S**

Solbjergvej 3, 5 sal  
2000 Frederiksberg  
Phone ++45/33 31 31 41  
Fax ++45/33 31 14 23

### ESTONIA

**B. Braun Medical OÜ**

Kadaka tee 70 b  
12618 Tallinn  
Phone ++372/6 77 12 00  
Fax ++372/6 77 12 09

### FINLAND

**B. Braun Medical Oy**

Huopalahdentie 24  
00350 Helsinki  
Phone ++358/20/17 72 700  
Fax ++358/20/17 72 720

### FRANCE

**B. Braun Medical S. A. S.**

204, Av. du Maréchal-Juin  
92107 Boulogne - Cedex  
Phone ++331/41 10 53 00  
Fax ++331/41 10 53 99

### HUNGARY

**B. Braun Medical Kft.**

Montevideo u. 2/c  
1037 Budapest  
Phone ++36/1/3 46 97 00  
Fax ++36/1/4 38 49 00

### IRELAND

**B. Braun Medical Ltd.**

3 Naas Road Industrial Park  
Dublin 12  
Phone ++353/1/4 55 31 11  
Fax ++353/1/4 55 31 15

### ITALY

**B. Braun Milano S. p. A.**

Via V. da Seregno, 14  
20161 Milano  
Phone ++39/02 66 21 81  
Fax ++39/02 66 21 82 90

### LATVIA

**B. Braun Medical SIA**

Udelu Str. 16  
1064 Riga, LV  
Phone ++371/678 19 549  
Fax ++371/678 19 547

### LITHUANIA

**B. Braun Medical UAB**

Ateities 10  
08303 Vilnius  
Phone ++370/2/37 43 33  
Fax ++370/2/37 43 44

### THE NETHERLANDS

**B. Braun Medical B. V.**

Euterpehof 10/Postbus 659  
5342 CW Oss/5340 AR Oss  
Phone ++31/4 12 67 24 11  
Fax ++31/4 12 67 24 90

### NORWAY

**B. Braun Medical A/S**

Kjaernasveien 13 B  
3142 Vestskogen  
Phone ++47/33 35 18 00  
Fax ++47/33 35 18 90

### POLAND

**Aesculap Chifa Sp. zo. o**

Tysiaclecia 14  
64300 Nowy Tomysl  
Phone ++48/61/44 20 100  
Fax ++48/61/4 42 39 36

### PORTUGAL

**B. Braun Medical Lda.**

Est. Consiglieri Pedroso, 80  
Queluz de Baixo  
2730-053 Barcarena  
Phone ++351/21/4 36 82 00  
Fax ++351/21/4 36 82 80

### RUSSIA

**B. Braun Medical LLC**

59, Bolshoy Pr.  
Petrogradskaja Side  
Saint Petersburg 197101  
Phone ++7 (812) 320-40-04  
Fax ++7 (812) 320-50-71

### SLOVAKIA

**B. Braun Medical s. r. o.**

Handlovska 19  
85101 Bratislava  
Phone ++421/2/63 83 89 20  
Fax ++421/2/63 82 76 97

### SPAIN

**B. Braun Medical S. A.**

Carretera de Terrassa, 121  
08191 Rubi (Barcelona)  
Phone ++34/93/5 86 62 00  
Fax ++34/ 93/5 88 10 96

### SWEDEN

**B. Braun Medical AB**

Svärdvägen 21  
18211 Danderyd  
Phone ++46/8/6 34 34 00  
Fax ++46/8/6 34 34 34

### SWITZERLAND

**B. Braun Medical AG**

Seesatz  
6204 Sempach  
Phone ++41/58 258 50 00  
Fax ++41/58 258 60 00

### TURKEY

**B. Braun Medical Irengrün Dis**

Ticaret A. S.  
Üniversite Mahallesi  
Civan Sokak No. 15 Aviclar  
34850 Istanbul  
Phone ++90/21 25 90 35 60  
Fax: ++90/21 25 91 94 30

### UNITED KINGDOM

**B. Braun Medical Ltd.**

Thorncliffe Park  
Sheffield S35 2PW  
Phone ++44/1 14/2 25 90 00  
Fax ++44/1 14/2 25 91 11

## NORTH AMERICA

### USA

**B. Braun Medical Inc.**

824 Twelfth Avenue  
Bethlehem, PA 18018  
Phone ++610-691-5400  
Fax: ++610-691-2202

## LATIN AMERICA

### ARGENTINA

**B. Braun Medical S. A.**

J. E. Uriburu, 663-7° Piso  
AR-(C1027AAM) Buenos Aires  
Phone ++541/1 49 54-20 30  
Fax ++541/1 49 54-75 27

### BRAZIL

**Laboratórios B. Braun S. A.**

Av. Eugenio Borges, 1092  
24751-000 Sao Goncalo RJ  
Phone ++5521/6 02 33 10  
Fax ++5521/6 02 31 89

### CHILE

**B. Braun Comercial S. A.**

Calle Nueva 5335 - Conchalí  
Santiago de Chile  
Phone ++562/4 40 71 00  
Fax ++562/6 23 01 00

### COLUMBIA

**B. Braun Medical S. A.**

Calle 44, No. 8-08  
Bogota D.C.  
Phone ++571/3 40 30 01  
Fax ++571/3 40 30 03

### ECUADOR

**B. Braun Medical S. A.**

Manuel Ambrosi 117y, Av. Eloy Alfaro  
Manuel Ambrosi 117y Los Cipreses  
Phone ++593/2/24 81/1 50  
Fax ++593/2/24 83/0 31

### MEXICO

**B. Braun Aesculap**

de México S. A. de C.V.  
Av. Vasco de Quiroga 2121 1er Piso  
Col. Santa Fe, Del. Alvaro Obrégón  
C. P. 01210 México, D.F.  
Phone ++52/55/50897800  
Fax ++52/55/50894975

**PERU**

**B. Braun Medical Peru S. A.**  
Av. Separadora Industrial No. 887  
Lima 3  
Phone ++511/3 26 18 25  
Fax ++511/3 26 79 90

**AUSTRALIA**

**B. Braun Australia Pty. Ltd.**  
Norwest Business Park  
17 Lexington Drive  
Bella Vista NSW 2153  
Phone ++61/2/96 29 02 00  
Fax ++61/2/96 29 02 99

**AFRICA****SOUTH AFRICA**

**B. Braun Medical Ltd.**  
Building 12B (Wentworth)  
Fourways Golf Park  
1016 Roos Street - Fourways  
2125 Gauteng  
Phone ++27/11/5485500  
Fax ++27/11/5485599

**ASIA****CHINA**

**B. Braun Medical (Shanghai)**  
International Trading Co. Ltd.  
21F, Sun Young Center  
398 Jianguo Road  
Shanghai 200050, PR China  
Phone ++86/21/22 16 30 00  
Fax ++86/21/32 50 60 10

**HONGKONG**

**B. Braun Medical (H.K.) Ltd.**  
13-14/F. Henan Building  
90 Jaffe Road Wanchai Hongkong  
Phone ++852/25/29 20 09  
Fax ++852/28/65 60 95

**INDIA**

**B. Braun Medical India Pvt Ltd**  
5th Floor, East Quadrant,  
The I.L & F.S. Financial Centre,  
Bandra - Kurla Complex,  
Bandra (E), Mumbai,  
400051 Maharashtra  
Phone ++91/22 66 68 22 22  
Fax ++91/22 66 68 21 21

**INDONESIA**

**PT. B. Braun Medical Indonesia**  
Century Tower 14th Floor ,  
Jl. HR. Rasuna Said Kav. X-2 No. 4,  
Jakarta 12950 , INDONESIA.  
Phone ++62 21 52907177  
Fax ++62 21 5290.7178

**JAPAN**

**B. Braun Aesculap Japan Co. Ltd.**  
38-16, Hongo 2-chome,  
Bunkyo-Ku  
Tokyo 113-0033  
Phone ++81/3/3814 2525  
Fax ++81/3/5684 7080

**MALAYSIA**

**B. Braun Medical Industries**  
Sdn. Bhd.  
Bayan Lepas Free Industrial Zone  
P.O. Box 880  
10810 Penang  
Phone ++60/4/6 32 31 00  
Fax ++60/4/6 43 37 50

**PAKISTAN**

**B. Braun Pakistan Ltd.**  
Plot E-3, Farzana Building, Room #11  
3rd Floor, Block 7&8,  
Main Shaheed-e-eMillat Road  
75400 Karachi  
Phone ++92/21/4 54 10 17  
Fax ++92/2 14 54 10 02

**PHILIPPINES**

**B. Braun Medical Supplies Inc.**  
2nd Floor, The JMT Corporate Center,  
ADB Avenue, 1605 Pasig City  
Phone ++632/633-72 84 to 95  
Fax ++632/633-72 98

**SINGAPORE**

**B. Braun Singapore Pte. Ltd.**  
600 North Bridge Road, #15-02/05  
Parkview Square  
188778 Singapore  
Phone ++65/6/2 13 09 33  
Fax ++65/6/2 13 09 30

**SOUTH KOREA**

**B. Braun Korea Co., Ltd.**  
13th Floor, POSCO Center Bldg. 892  
Daechi 4-Dong  
Kangnam-Ku  
135-777 Seoul  
Phone ++82/2 34 59 78 00  
Fax ++82/2 34 53 30 60

**TAIWAN**

**B. Braun Taiwan Co. Ltd.**  
11/F, No. 132, Nanking E. Road, Sec. 3  
104 Taipei  
Phone ++886/2/27 21 99 00  
Fax ++886/2/27 31 66 28

**VIETNAM**

**B. Braun Vietnam Co., Ltd.**  
170 La Thanh Street - Dong Da District  
Hanoi  
Phone ++84/4/35 11 00 88  
Fax ++84/4/38 51 00 72

**For further information about  
dealer networks etc. please contact  
the Vascular Systems head office in  
Berlin.**

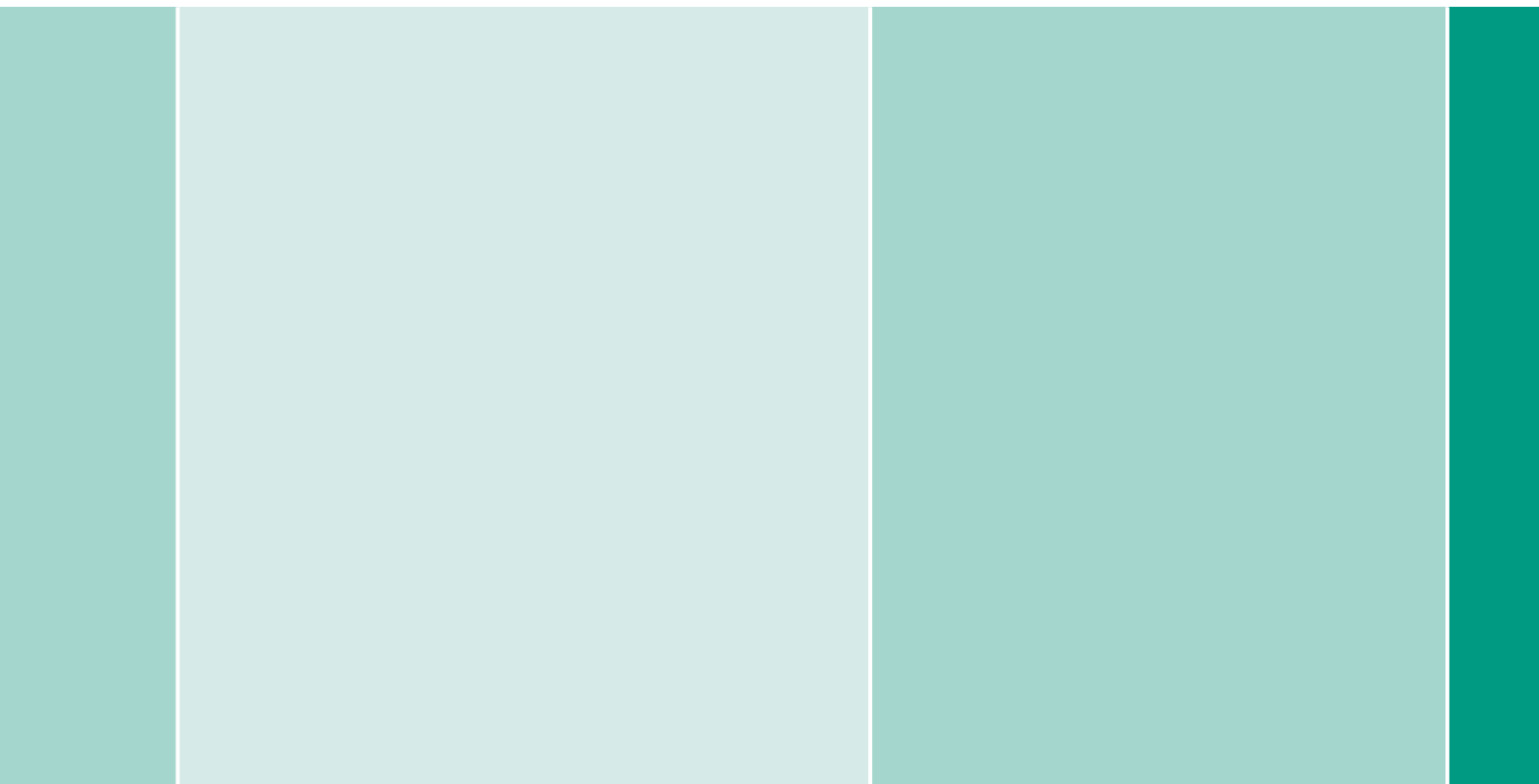

B. Braun Melsungen AG | Vascular Systems | Sieversufer 8 | 12359 Berlin | Germany  
Phone +49 30 689897-0 | Fax +49 30 689897-30 | [www.bbraun.com](http://www.bbraun.com)

Aesculap AG | Am Aesculap-Platz | 78532 Tuttlingen | Germany  
Phone +49 7461 95-0 | Fax +49 7461 95-26 00 | [www.aesculap.com](http://www.aesculap.com)

Aesculap – a B. Braun company

Subject to technical changes. All rights reserved.  
This brochure may only be used for the exclusive  
purpose of obtaining information about our  
products. Reproduction in any form partial or  
otherwise is not permitted.

Brochure No. 6050166

1012/1.0/5